

Super-precision angular contact ball bearings: High-capacity

719 .. D (SEB) and 70 .. D (EX) series



www.lager-technik.eu



The SKF brand now stands for more than ever before, and means more to you as a valued customer.

While SKF maintains its leadership as a high-quality bearing manufacturer throughout the world, new dimensions in technical advances, product support and services have evolved SKF into a truly solutions-oriented supplier, creating greater value for customers.

These solutions enable customers to improve productivity, not only with breakthrough application-specific products, but also through leading-edge design simulation tools and consultancy services, plant asset efficiency maintenance programmes, and the industry's most advanced supply management techniques.

The SKF brand still stands for the very best in rolling bearings, but it now stands for much more.

SKF – the knowledge engineering company

Contents

A Product information

SKF super-precision angular contact ball bearings in the 719 .. D (SEB) and 70 .. D (EX) series 3

The assortment 4
High-capacity, D design bearings 4
Bearing series 6
Bearing variants 6
Single bearings and matched bearing sets 7

Applications 8

B Recommendations

Bearing arrangement design 10
Single bearings 10
Bearing sets 10
Types of arrangement 11
Application examples 12

Lubrication 14
Grease lubrication 14
Oil lubrication 16

C Product data

Bearing data – general 18
Boundary dimensions 18
Tolerances 18
Bearing preload 19
Bearing axial stiffness 23
Fitting and clamping bearing rings 26
Load carrying capacity of bearing sets 28
Equivalent bearing loads 28
Attainable speeds 30
Cages 30
Seals 30
Materials 31
Heat treatment 31
Markings on bearings and bearing sets 32
Packaging 33
Designation system 33

Product tables 36

D Additional information

SKF new generation super-precision bearings 50
Super-precision angular contact ball bearings 50
Super-precision cylindrical roller bearings 51
Super-precision double direction angular contact thrust ball bearings 51
Super-precision angular contact thrust ball bearings for screw drives 51

SKF – the knowledge engineering company 54

SKF super-precision angular contact ball bearings in the 719 .. D (*SEB*) and 70 .. D (*EX*) series

The comprehensive assortment of SKF super-precision bearings is designed for machine tool spindles and other precision applications requiring superior bearing performance. Extended speed capability, a high degree of running accuracy, high system rigidity, low heat generation, as well as low noise and vibration levels are just some of the performance challenges. For applications where a high load carrying capacity is an additional operational requirement, SKF offers an assortment of super-precision high-capacity angular contact ball bearings.

The existing high-capacity 72 .. D (*E 200*)¹⁾ series is now complemented by high-capacity bearings in the 719 .. D (*SEB*) and 70 .. D (*EX*) series. The ability of the new design super-precision bearings in these two series to accommodate heavy loads in applications where radial space is often limited, makes them an excellent choice for demanding applications.

The bearings are characterized by:

- high load carrying capacity
- relatively high speed capability
- high degree of stiffness
- extended bearing service life
- low heat generation
- compact cross section

Bearings in the 719 .. D (*SEB*) and 70 .. D (*EX*) series provide high reliability and superior accuracy for various machine tool applications as well as other applications including boat gyrostabilizers, microturbines, machine components for the semiconductor industry, and wheels on race cars.



¹⁾ Where applicable, designations in parentheses and italics refer to the corresponding SNFA equivalent.

The assortment

The new, super-precision bearings in the 719 .. D (*SEB*) and 70 .. D (*EX*) series are available in an extended range as follows:

- Open bearings in the 719 .. D (*SEB*) series accommodate shaft diameters ranging from 10 to 360 mm; sealed bearings from 10 to 150 mm.
- Open bearings in the 70 .. D (*EX*) series accommodate shaft diameters ranging from 6 to 240 mm; sealed bearings from 10 to 150 mm.

Bearings in both series are available with two contact angles, two ball materials, two ring materials and can be manufactured to two tolerance classes. Most bearings have a phenolic resin cage, as standard, except for the three largest sizes, which have a machined brass cage. The most common sizes are also available with a PEEK cage, to accommodate extended operating temperatures.

Those suitable for universal matching or mounting in sets are produced to four preload classes, to meet almost all application requirements in terms of speed and rigidity. Matched bearing sets with a special preload can be supplied on request. Bearing

variants for direct oil lubrication are also available, on request.

Bearings in the 719 .. D (*SEB*) and 70 .. D (*EX*) series, like all angular contact ball bearings, are nearly always adjusted against a second bearing to balance the counterforces. To accommodate heavier loads and axial loads in both directions, the bearings are used in sets consisting typically of up to four bearings.

High-capacity, D design bearings

Super-precision single row angular contact ball bearings in the 719 .. D (*SEB*) and 70 .. D (*EX*) series are designed to accommodate heavy loads at relatively high speeds.



Features and benefits of SKF super-precision angular contact ball bearings: 719 .. D (*SEB*) and 70 .. D (*EX*) series

Features

- Large balls
- P4A or PA9A tolerance classes
- Optimized chamfer design
- ISO 19 and ISO 10 dimension series
- High-nitrogen stainless steel rings (NitroMax variant)
- Non-contact seals (sealed variant)
- Ready-to-mount (sealed variant)
- Relubrication-free (sealed variant)
- Lubrication features (direct oil lubrication variants)
- Asymmetrical outer ring
- High-temperature PEEK cage, for most common sizes
- Optimized cage design (phenolic resin and brass)

Benefits

- High load carrying capacity, high degree of rigidity
- Superior running accuracy, short running-in time
- Facilitated mounting
- Compact cross sections
- Extended bearing service life, superior corrosion resistance
- Prevent entry of contaminants, relatively high speed capability
- Reduced mounting time
- Reduced maintenance
- Optimized oil lubrication
- Accommodate radial loads, and axial loads in one direction
- Accommodate operating temperatures up to 150 °C
- Optimized guiding clearance, good lubricant supply to ball/raceway contact area

Features of D design bearings include:

- a symmetrical inner ring
- an asymmetrical outer ring
- large balls
- an outer ring shoulder-guided cage
- an optimized chamfer design

The design of the symmetrical inner ring and asymmetrical outer ring enables the bearings to accommodate radial loads, and axial loads in one direction. When compared to other precision angular contact ball bearings, D design bearings have larger balls to accommodate heavier loads.

The bearings have an outer ring shoulder-guided cage made of either fabric reinforced phenolic resin or machined brass. These cages are designed to enable good lubricant supply to the ball/raceway contact area. The guiding clearance between the cage and the outer ring is optimized for improved behaviour at high speeds. The most common bearings are also available with a glass fibre reinforced polyetheretherketone (PEEK) cage, on request.

The shape of the chamfers on the inner and outer rings is optimized for improved mounting accuracy. As a result, mounting is not only facilitated, but there is also less risk of damage to associated components.

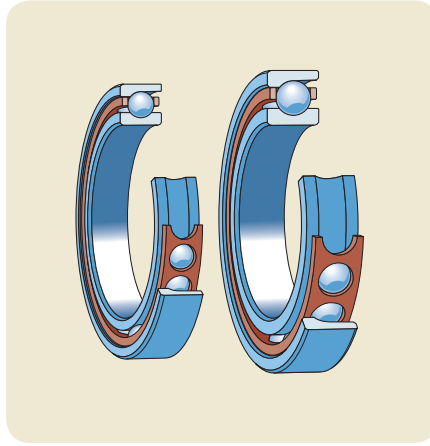

D design bearings have large balls to accommodate heavy loads.

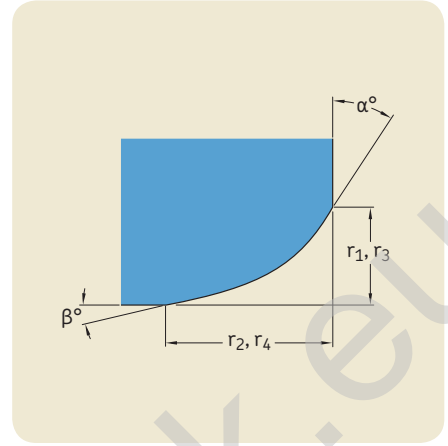

Optimized design of the bearing ring chamfers facilitates mounting.

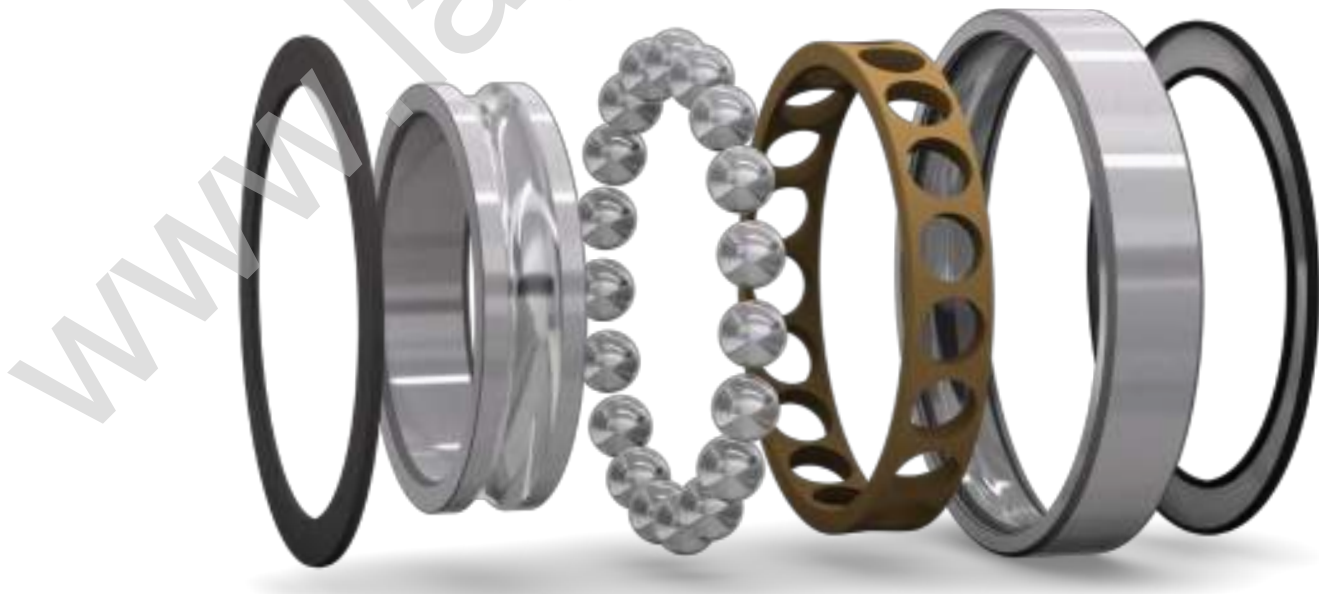

Bearing series

The assortment of super-precision bearings presented in this brochure includes two ISO dimension series:

- the extremely light 19 series
- the light 10 series

Bearings in both these series are suitable for relatively high operational speeds and where there is tight radial mounting space.

Bearing variants

Based on the operating conditions in precision applications, bearing requirements can vary. As a result, there are many variants of SKF super-precision angular contact ball bearings in the 719 .. D (*SEB*) and 70 .. D (*EX*) series to choose from.

Contact angles

Standard bearings are manufactured with the following contact angles:

- a 15° contact angle, designation suffix CD (1)
- a 25° contact angle, designation suffix ACD (3)

With two contact angles to choose from, designers can optimize their application based on axial load, speed and rigidity requirements. A larger contact angle provides a higher degree of axial stiffness and a higher axial load carrying capacity. However, this reduces speed capability.

Ball materials

Bearings in the 719 .. D (*SEB*) series with a bore diameter $d \leq 170$ mm, and in the 70 .. D (*EX*) series with a bore diameter $d \leq 120$ mm are available, standard, with:

- steel balls, no designation suffix
- ceramic (bearing grade silicon nitride) balls, designation suffix HC (*NS*)

Larger bearings are available, standard, with steel balls, but can be supplied with ceramic balls on request.

As ceramic balls are considerably lighter and harder than steel balls, hybrid bearings can provide a higher degree of rigidity and run considerably faster than comparably sized all-steel bearings. The lower weight of the ceramic balls reduces the centrifugal forces within the bearing and generates less heat. Lower centrifugal forces are particularly important in machine tool applications where there are frequent rapid starts and stops. Less heat generated by the bearing means less energy consumption and longer bearing and grease service life.

Series comparison

When increased system rigidity is required, bearings in the 719 series accommodate a larger shaft diameter for a given outside diameter, compared to bearings in the 70 series.

Two contact angles accommodate different axial load, speed and rigidity requirements.

The bearings are available in an all-steel and hybrid variant.

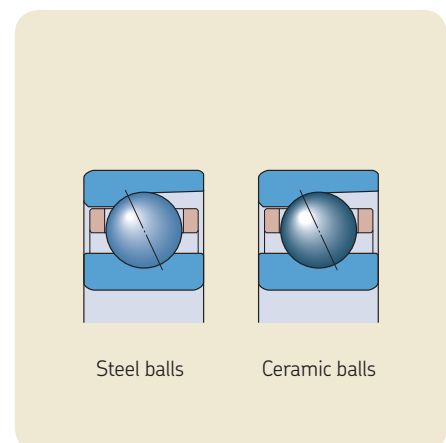
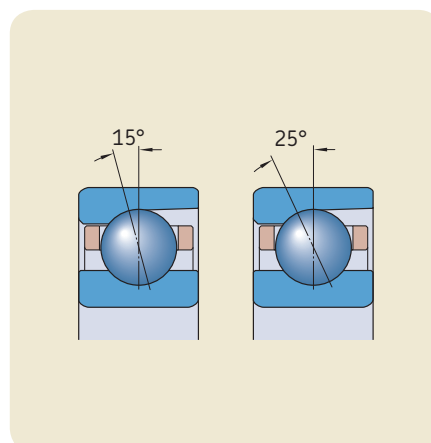
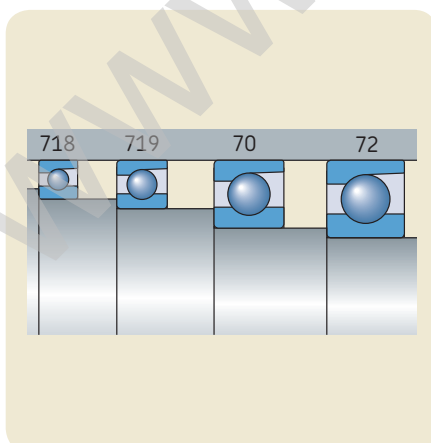

Sealed bearings

Bearings in the most common sizes can be supplied with an integral seal fitted on both sides and filled with premium grease. The seal forms an extremely narrow gap with the cylindrical surface of the inner ring shoulder, and therefore speed capability is not compromised.

When compared to bearing arrangements with open bearings and external seals, those with sealed bearings provide a number of advantages including:

- extended bearing service life
- reduced need for maintenance
- reduced inventory
- reduced risk of lubricant contamination during mounting and operation

The most common bearings are available in a sealed variant.

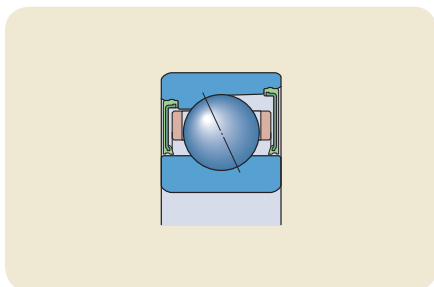

Sealed bearings are identified by the designation prefix *S* (suffix */S*).

Bearings made from NitroMax steel

Bearings in the 719 .. D (*SEB*) and 70 .. D (*EX*) series can be supplied with rings made from NitroMax steel. NitroMax is a new generation high-nitrogen stainless steel with superior corrosion resistance, enhanced fatigue strength and a high degree of impact toughness. This ultra-clean steel can extend bearing service life in applications under good (full-film) as well as critical (thin-film) lubrication conditions.

Standard bearings made from NitroMax steel are supplied with ceramic balls. The combined properties of the NitroMax steel rings and ceramic balls greatly improve bearing performance, enabling these bearings to run several times longer than conventional hybrid bearings.

Sealed hybrid bearings made from NitroMax steel are identified by the designation prefix *SV* (suffix */S/XN*).

Open bearings for direct oil lubrication

To accommodate direct oil lubrication, the outer ring of open bearings can be manufactured with two lubrication holes, on request. An annular groove as well as additional sealing features, such as annular grooves fitted with O-rings, are available, depending on the bearing series.

Single bearings and matched bearing sets

Bearings in 719 .. D (*SEB*) and 70 .. D (*EX*) series are available, standard, as:

- single bearings
- single, universally matchable bearings
- matched bearing sets
- sets of universally matchable bearings

Bearing variants for direct oil lubrication

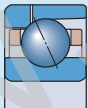
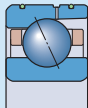
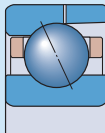
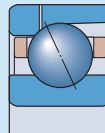
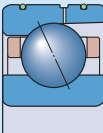
Description	Bearing variant for open bearings in the series 719 .. D (<i>SEB</i>)		70 .. D (<i>EX</i>)		
					
Designation suffix	H1 (<i>H1</i>)	L (<i>GH</i>)	H (<i>H</i>)	H1 (<i>H1</i>)	L (<i>GH</i>)
Lubrication features	Two lubrication holes in the outer ring	Annular groove and two lubrication holes in the outer ring	Two lubrication holes in the outer ring	Two lubrication holes in the outer ring	Annular groove and two lubrication holes in the outer ring
Sealing features	None	Two annular grooves in the outer ring fitted with O-rings	None	None	Two annular grooves in the outer ring fitted with O-rings

Applications

The SKF assortment of super-precision angular contact ball bearings in the 719 .. D (SEB) and 70 .. D (EX) series offers solutions to many bearing arrangement challenges. Their ability, among others, to provide a high degree of rigidity and accommodate heavy loads at relatively high speeds is beneficial for a variety of applications.

In machining centres and grinding machines, for example, relatively heavy combined loads and high positioning accuracy are key operational parameters. In the semiconductor industry, the fabrication of silicon wafer chips for integrated electronic circuits compromises various precision processes that require superior running accuracy.

In the highly contaminated environment of many precision applications, one of the primary causes of premature bearing failure is the ingress of solid contaminants and/or cutting fluid into the bearing cavity. To virtually eliminate this problem, sealed bearings in the S719 .. D (SEB .. /S) and S70 .. D (EX .. /S) series are an excellent solution.

Applications

- Machining centres (horizontal and vertical)
- Milling machines
- Lathes
- External and surface grinding machines
- Boring machines
- Machines for cutting or polishing stones and glass
- Semiconductor industry
- Boat gyrostabilizers
- Telescopes
- Microturbines
- Racing/super car wheels
- Medical equipment

Requirements

- High load carrying capacity
- High-speed capability
- High positioning accuracy
- High degree of system rigidity
- Low energy consumption
- Long service life
- Facilitated mounting
- Increased machine uptime
- High power density for compact designs
- Effective sealing against contaminants

Solution



SKF super-precision angular contact ball bearings in the 719 .. D (SEB) and 70 .. D (EX) series



Bearing arrangement design

Bearing arrangements using SKF super-precision angular contact ball bearings in the 719 .. D (*SEB*) and 70 .. D (*EX*) series can be designed using single bearings or bearing sets. An example of how to order bearings for a three-bearing arrangement is provided in **table 1**.

Single bearings

Bearings in the 719 .. D (*SEB*) and 70 .. D (*EX*) series are available as single (stand-alone) bearings or single, universally matchable bearings. When ordering single bearings, indicate the number of individual bearings required.

Single bearings

Single bearings are intended for arrangements where only one bearing is used in each bearing position.

Although the widths of the bearing rings are made to very tight tolerances, these bearings are not suitable for mounting immediately adjacent to each other.

Single, universally matchable bearings

Universally matchable bearings are specifically manufactured so that when mounted in random order, but immediately adjacent to each other, a given preload and/or even load distribution is obtained without the use of shims or similar devices. These bearings can be mounted in random order for any desired bearing arrangement.

Single, universally matchable bearings are available in four preload classes and are identified by the designation suffix G (*U*).

Bearing sets

Bearings in the 719 .. D (*SEB*) and 70 .. D (*EX*) series are available as matched bearing sets or as sets of universally matchable bearings. When ordering bearing sets, indicate the number of bearing sets required (the number of individual bearings per set is specified in the designation).

Matched bearing sets

Bearings can be supplied as a complete bearing set consisting of two, three or four bearings. The bearings are matched to each other during production so that when mounted immediately adjacent to each other, in a specified order, a given preload and/or even load distribution is obtained without the use of shims or similar devices. The bore and outside diameters of these bearings are matched to within a maximum of one-third of the applicable permitted diameter tolerance, resulting in better load distribution, when mounted, than single universally matchable bearings.

Matched bearing sets are available in four preload classes.

Sets of universally matchable bearings

The bearings in these sets can be mounted in random order for any desired bearing arrangement. The bore and outside diameters of a set of universally matchable bearings are matched to within a maximum of one-third of the applicable permitted diameter tolerance, resulting in better load distri-

Table 1

Example of the ordering possibilities for a three-bearing arrangement

Design criteria	What to order	Bearing designation ¹⁾	Order example
Bearing arrangement is not known	Three single, universally matchable bearings	70 .. DG../P4A (EX.. 7CE .. U.)	3 x 7014 CDGA/P4A (3 x EX 70 7CE1 UL)
Bearing arrangement is not known and improved load distribution is desirable	A set of three universally matchable bearings	70 .. D/P4ATG.. (EX.. 7CE .. TU..)	1 x 7014 CD/P4ATGA (1 x EX 70 7CE1 TUL)
Bearing arrangement is known	Three bearings in a matched set	70 .. D/P4AT.. (EX.. 7CE .. T..)	1 x 7014 CD/P4ATBTA (1 x EX 70 7CE1 TDL)

¹⁾ For additional information about designations, refer to **table 16** on **pages 34** and **35**.

bution, when mounted, than single universally matchable bearings.

Sets of universally matchable bearings are available in four preload classes. Like single, universally matchable bearings, sets of universally matchable bearings are identified by the designation suffix G (U), but their positions in the designation differ (→ table 1).

Types of arrangement

Universally matchable bearings and matched bearing sets can be arranged in various configurations depending on the stiffness, rigidity and load requirements of the application. The possible configurations are shown in **fig. 1**, including the designation suffixes applicable to matched bearing sets.

Back-to-back bearing arrangement

In a back-to-back bearing arrangement, the load lines diverge toward the bearing axis. Axial loads acting in both directions can be accommodated, but only by one bearing or bearing set in one direction each. Bearings mounted back-to-back provide a relatively rigid bearing arrangement that can also accommodate tilting moments.

Face-to-face bearing arrangement

In a face-to-face bearing arrangement, the load lines converge toward the bearing axis. Axial loads acting in both directions can be accommodated, but only by one bearing or bearing set in one direction each. Face-to-face arrangements are less suitable to accommodate tilting moments.

Tandem bearing arrangement

The axial load carrying capacity of a bearing arrangement can be increased by adding bearings mounted in tandem. In a tandem bearing arrangement, the load lines are parallel so that radial and axial loads are shared equally by the bearings in the set. The bearing set can only accommodate axial loads acting in one direction. If axial loads act in the opposite direction, or if combined loads are present, additional bearing(s)

adjusted against the tandem arrangement should be added.

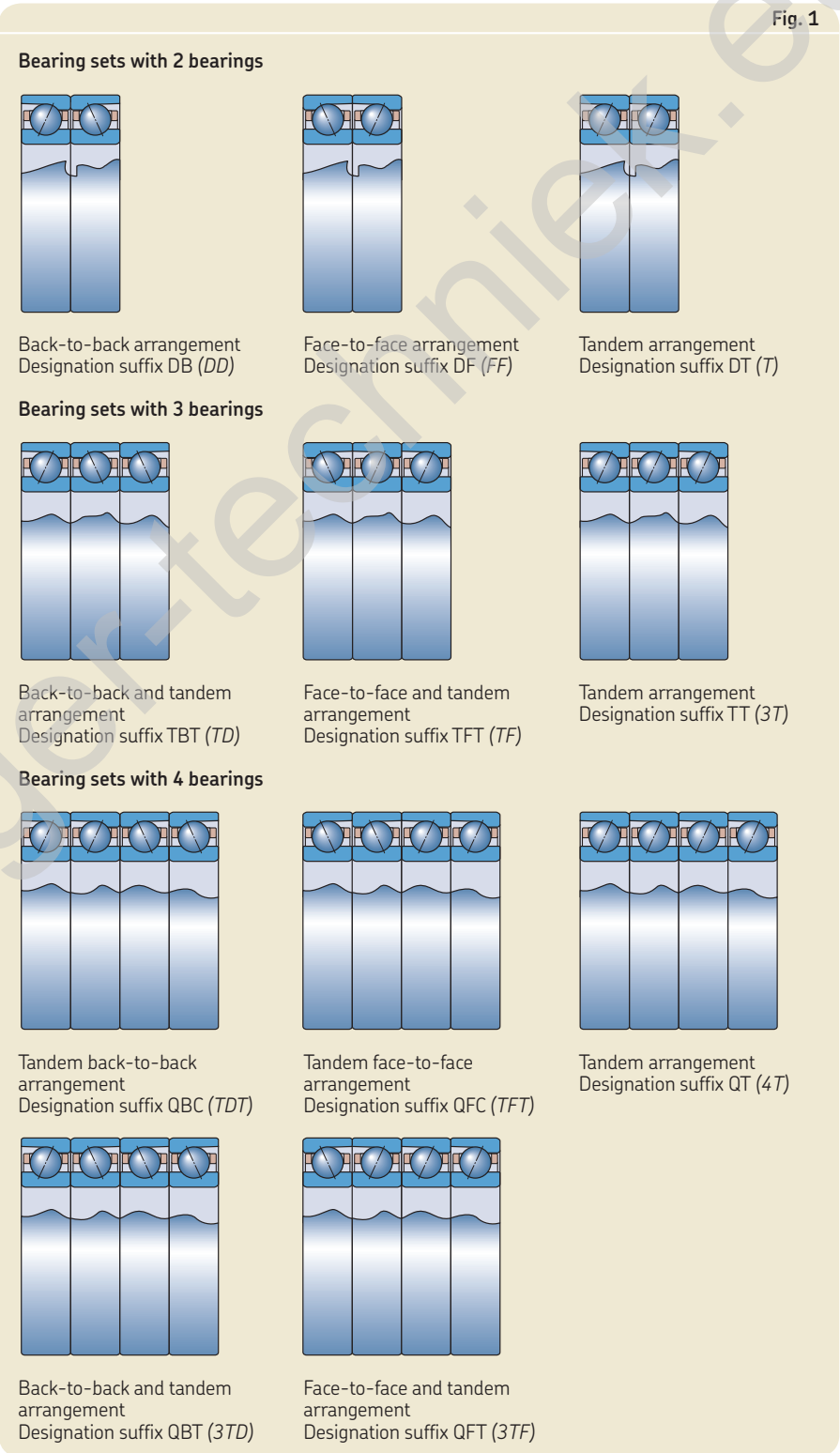

Application examples

Super-precision angular contact ball bearings are common in, but not limited to, machine tool spindles. Depending on the type of machine tool and its intended purpose, spindles may require different bearing arrangements.

Bearings in the 719 .. D (SEB) and 70 .. D (EX) series enable the design of compact bearing arrangements, which is beneficial where radial space is limited.

In machining centres, grinding spindles and milling machines that are subjected to heavy combined loads at relatively high operational speeds, it is common to have sets of super-precision angular contact ball bearings in the 719 .. D (SEB) and 70 .. D (EX) series at the tool and non-tool ends of the shaft.

When high operational speeds and high load carrying capacity are required, as it is with boat gyrostabilizers, hybrid angular contact ball bearings in the 70 .. D (EX) series provide an excellent solution.

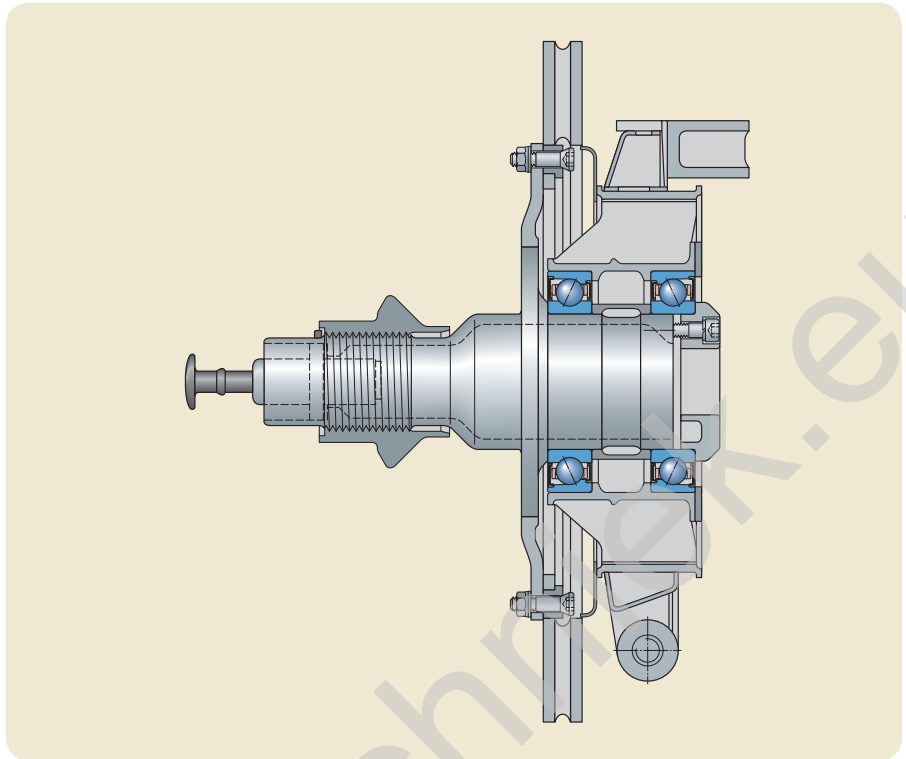

Wheel on a race car

In the racing environment, high running accuracy, low friction, light weight, and an effective sealing solution are key operational requirements. In this wheel application, two universally matchable sealed super-precision angular contact ball bearings are mounted in a back-to-back arrangement. The bearings were designed for especially low friction, e.g. S7011 ACDGA/P4AVP304.

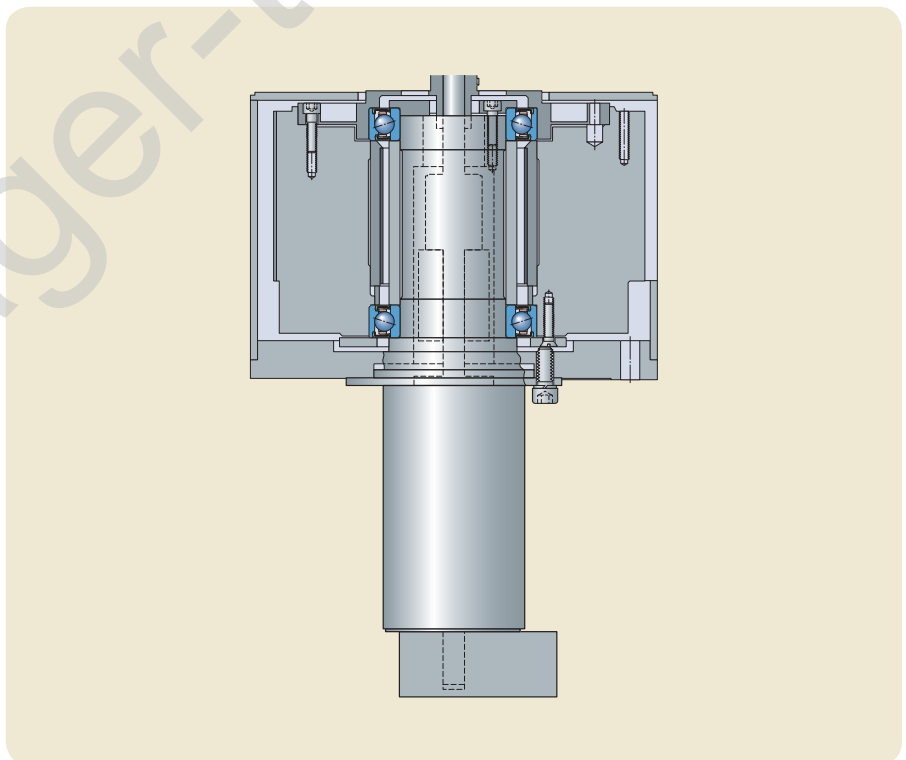

Unit for detecting defects on silicon wafer chips

This unit, which has eight mirrors, detects defects on silicon wafer chips using a high-accuracy laser beam. The unit has a matched pair of sealed super-precision angular contact ball bearings, arranged back-to-back, e.g. S71906 CD/P4ADBA (SEB 30 /S 7CE1 DD2,5daN). The bearings are filled with a special grease under clean room conditions.

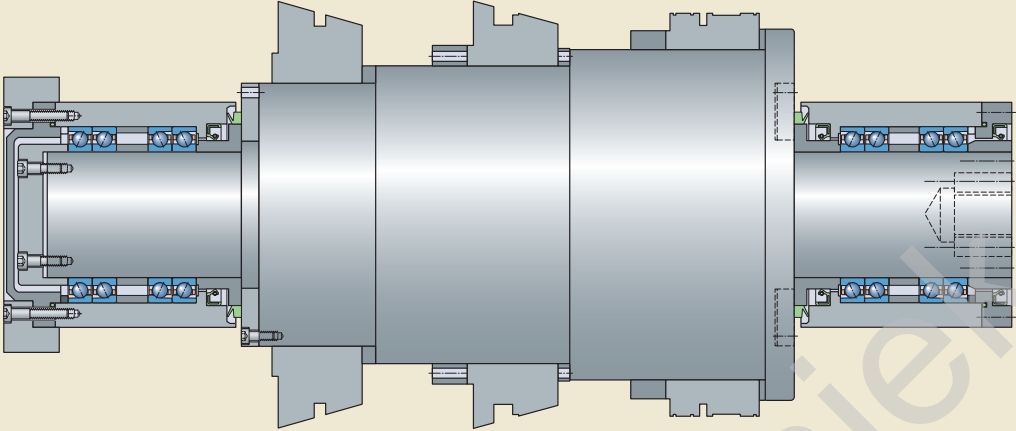

Centreless grinder

A high-capacity centreless grinder generates high loads and requires a high degree of system rigidity. Often, radial space is limited. This spindle has two sets of four super-precision angular contact ball bearings, arranged tandem back-to-back, e.g. 2 x 71926 ACD/P4AQBGA (SEB 130 7CE3 TDTL), and separated by precision-matched spacer rings.

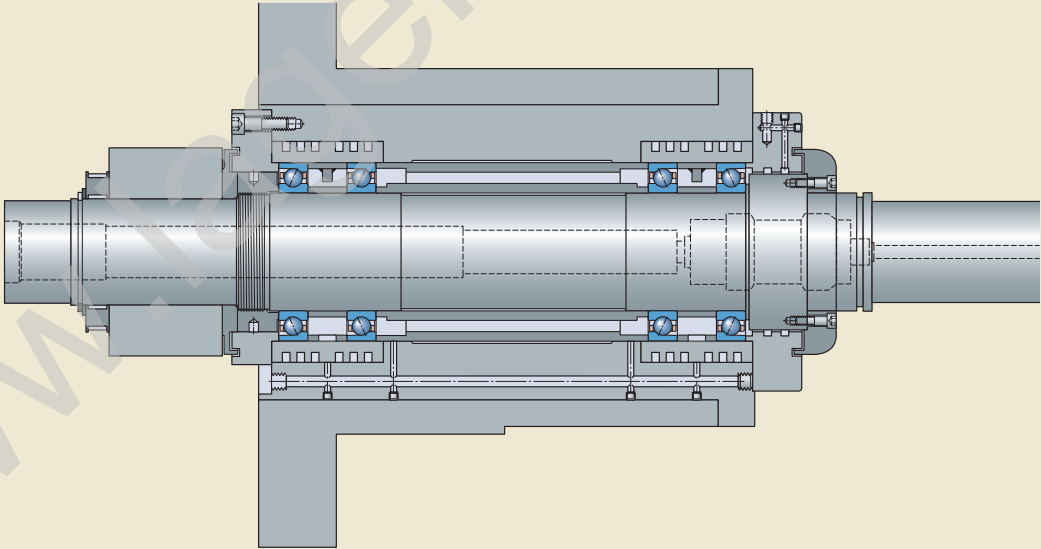

Horizontal machining centre

This spindle, which operates at high speeds under heavy loads, uses a matched set of four super-precision angular contact ball bearings mounted in a tandem back-to-back arrangement and separated by a set of precision-matched spacer rings, e.g. 7020 CD/P4AQBGA (EX 100 7CE1 TDT62daN). The spindle is designed for an oil-air lubrication system.

Lubrication

Heat resulting from friction is a constant threat to production equipment. One way to reduce heat and the wear associated with friction, particularly in bearings, is to be sure that the correct quantity of the appropriate lubricant reaches all necessary parts.

Grease lubrication

Open bearings

In most applications with open bearings in the 719 .. D (SEB) and 70 .. D (EX) series, grease with a mineral base oil and lithium thickener is suitable. These greases, which adhere well to the bearing surfaces, can accommodate operating temperatures ranging from -30 to $+100$ °C.

In high-speed applications, less than 30% of the free space in the bearings should be filled with grease. The initial grease fill depends on the bearing series and size as well as the speed factor, which is

$$A = n d_m$$

where

$$\begin{aligned} A &= \text{speed factor [mm/min]} \\ n &= \text{rotational speed [r/min]} \\ d_m &= \text{bearing mean diameter} \\ &= 0,5 (d + D) \text{ [mm]} \end{aligned}$$

The initial grease fill for open bearings can be estimated by

$$G = K G_{\text{ref}}$$

where

$$\begin{aligned} G &= \text{initial grease fill [cm}^3\text{]} \\ K &= \text{a calculation factor dependent on} \\ &\quad \text{the speed factor A (} \rightarrow \text{ diagram 1)} \\ G_{\text{ref}} &= \text{reference grease quantity (} \rightarrow \text{ table 1)} \\ &\quad \text{[cm}^3\text{]} \end{aligned}$$

Sealed bearings

Sealed bearings in the S719 .. D (SEB .. /S) and S70 .. D (EX .. /S) series are filled with a high-grade, low viscosity grease that fills approximately 15% of the free space in the bearing. The bearings are relubrication-free under normal operating conditions.

The grease is characterized by:

- high-speed capability
- excellent ageing resistance
- very good rust inhibiting properties

The technical specifications of the grease are provided in **table 2**.

Running-in of open and sealed, grease lubricated bearings

A grease lubricated super-precision bearing will initially run with a relatively high frictional moment. If the bearing is run at high speed without a running-in period, the temperature rise can be considerable. The relatively high frictional moment is due to the churning of the grease and it takes time for the excess grease to work its way out of the contact zone.

For open bearings, this time period can be minimized by applying a small quantity of grease distributed evenly on both sides of the bearing during assembly. Spacers between two adjacent bearings are also beneficial (\rightarrow *Adjusting preload with spacer rings*, **page 23**).

The time required to stabilize the operating temperature depends on a number of factors – the type of grease, the initial grease fill, how the grease is applied to the bearings and the running-in procedure (\rightarrow **diagram 2** on **page 16**).

Diagram 1

Factor K for initial grease fill (estimated)

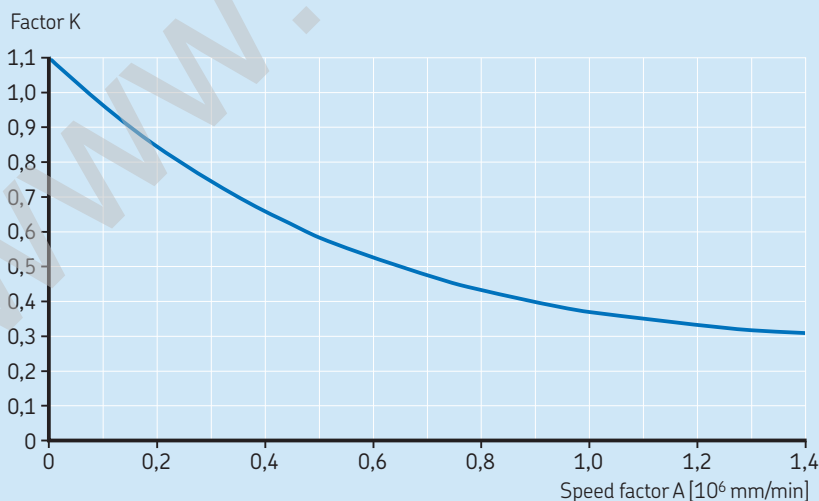

Super-precision bearings can typically operate with a minimum quantity of lubricant when properly run-in, enabling the lowest frictional moment and temperature to be achieved. Grease that collects on each side of the bearing acts as a reservoir, enabling oil to bleed into the raceway to provide effective lubrication for a long time.

Running-in can be done in several ways. Wherever possible and regardless of the procedure chosen, running-in should involve operating the bearing in both a clockwise and anticlockwise direction. For additional information about running-in procedures, refer to the *SKF Interactive Engineering Catalogue* available online at www.skf.com.

Table 1

Reference grease quantity for initial grease fill estimation

Bearing Bore diameter d	Size	Reference grease quantity ¹⁾ for open bearings in the series 719 .. D (SEB) 70 .. D (EX)	
		G_{ref}	
mm	–	cm ³	
6	6	–	0,09
7	7	–	0,12
8	8	–	0,15
9	9	–	0,18
10	00	0,12	0,24
12	01	0,12	0,27
15	02	0,21	0,39
17	03	0,24	0,54
20	04	0,45	0,9
25	05	0,54	1,02
30	06	0,63	1,59
35	07	0,93	1,98
40	08	1,44	2,4
45	09	1,62	3,3
50	10	1,74	3,6
55	11	2,49	5,1
60	12	2,7	5,4
65	13	2,85	5,7
70	14	4,5	8,1
75	15	5,1	8,4
80	16	5,1	11,1
85	17	7,2	11,7
90	18	7,5	15
95	19	7,8	15,6
100	20	10,5	16,2
105	21	11,1	20,4
110	22	11,4	25,5
120	24	15,3	27
130	26	20,4	42
140	28	21,6	45
150	30	33	54
160	32	33	66
170	34	36	84
180	36	54	111
190	38	57	114
200	40	81	153
220	44	84	201
240	48	93	216
260	52	150	–
280	56	159	–
300	60	265	–
320	64	282	–
340	68	294	–
360	72	313	–

¹⁾ Refers to a 30% filling grade.

Table 2

Technical specifications of the grease in sealed bearings

Properties	Grease specification
Thickener	Special lithium soap
Base oil type	Ester/PAO
NLGI consistency class	2
Temperature range [°C] [°F]	–40 to +120 –40 to +250
Kinematic viscosity [mm ² /s] at 40 °C at 100 °C	25 6

Oil lubrication

Oil lubrication is recommended for open bearings in the 719 .. D (SEB) and 70 .. D (EX) series where very high speeds preclude the use of grease as a lubricant.

Oil-air lubrication method

In some precision applications, the very high operational speeds and requisite low operating temperatures generally require an oil-air lubrication system. With the oil-air method, also called the oil-spot method, accurately metered quantities of oil are directed at each individual bearing by compressed air. For bearings used in sets, each

bearing is supplied by a separate injector. Most designs include special spacers that incorporate the oil nozzles.

Guidelines for the quantity of oil to be supplied to each bearing for very high speed operation can be obtained from

$$Q = 1,3 d_m$$

where

Q = oil flow rate [mm³/h]

d_m = bearing mean diameter
= 0,5 (d + D) [mm]

The calculated oil flow rate should be verified during operation and adjusted, depending on the resulting temperatures.

Oil is supplied to the feed lines at given intervals by a metering unit. The oil coats the inside surface of the feed lines and "creeps" toward the nozzles (→ fig. 1), where it is delivered to the bearings. The oil nozzles should be positioned correctly (→ table 3) to make sure that the oil is introduced into the contact area between the balls and raceways and to avoid interference with the cage.

High quality lubricating oils without EP additives are generally recommended for super-precision angular contact ball bearings. Oils with a viscosity of 40 to 100 mm²/s at 40 °C are typically used. A filter that prevents particles > 5 µm from reaching the bearings should also be incorporated.

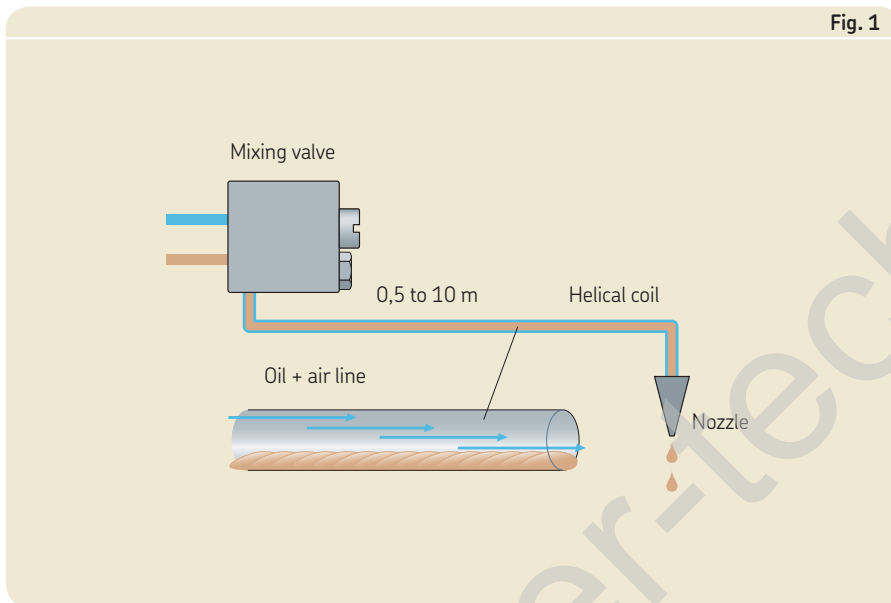

Fig. 1

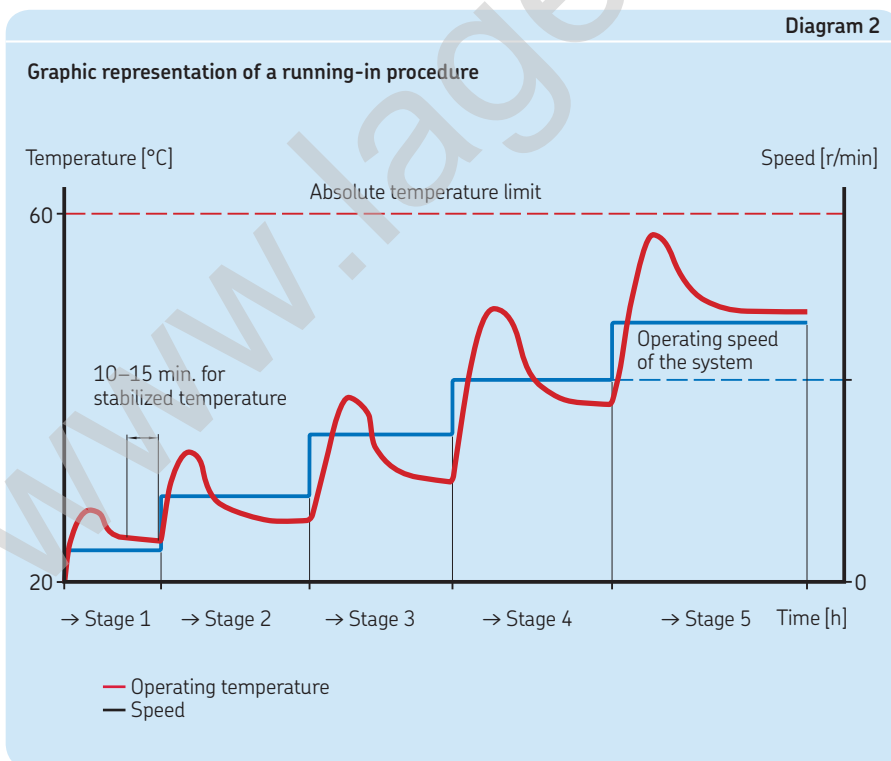

Diagram 2

Oil jet lubrication method

For very high operational speeds, a sufficient but not excessive amount of oil should be supplied to the bearing to provide adequate lubrication without increasing the operating temperature unnecessarily. One particularly efficient method of achieving this is the oil jet method, where a jet of oil under high pressure is directed at the side of the bearing.

The velocity of the oil jet should be sufficiently high (at least 15 m/s) to penetrate the turbulence surrounding the rotating bearing. It is important that the oil leaving the bearing can be discharged from the arrangement by adequately dimensioned ducts.

Direct oil lubrication

For very high operational speeds, the injection of small amounts of oil-air into the bearing is beneficial. With this method, lubricant dispersion is prevented, as the lubricant is supplied directly and safely to the ball/raceway contact area through the outer ring. As a result, lubricant consumption is minimized and bearing performance is improved.

There are two bearing variants in the 719 .. D (SEB) series and three bearing variants in the 70 .. D (EX) series for direct oil lubrication (→ *Bearing variants*, page 6).

To select the most appropriate variant for direct oil lubrication, keep the following in mind:

- Bearings with an annular groove in the outer ring that coincides with the two lubrication holes enable a more reliable supply of lubricant through the outer ring, compared to those without an annular groove.
- Bearings with lubrication holes manufactured on the thicker bearing shoulder side enable the lubricant to be supplied very close to the ball/raceway contact area. These bearings can therefore be used to achieve maximum speeds.
- To prevent lubricant leakage between the bearing outside diameter and the housing bore, bearings fitted with O-rings in the outer ring are an excellent solution, as no additional machining is required. When bearings without this sealing feature are used, SKF recommends machining the housing bore and incorporating O-rings into the bearing arrangement design (→ fig. 2).

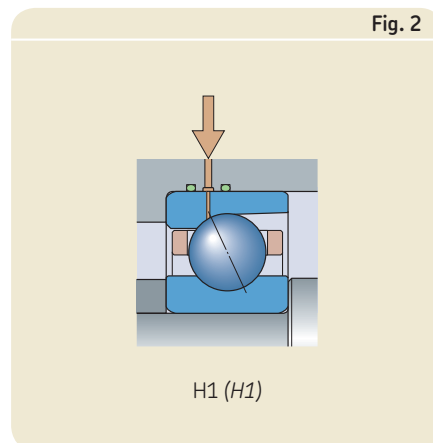
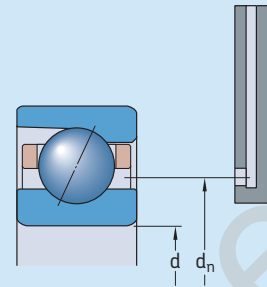

Table 3

Oil nozzle position for oil-air lubrication



Bearing Bore diameter	Size	Oil nozzle position for open bearings in the series	
		719 .. D (SEB)	70 .. D (EX)
d		d _n	
mm	–	mm	
6	6	–	10,3
7	7	–	11,7
8	8	–	13,6
9	9	–	15,1
10	00	14,8	16
12	01	16,8	18
15	02	20,1	21,5
17	03	22,1	23,7
20	04	26,8	28,4
25	05	31,8	33,4
30	06	36,8	39,3
35	07	43	45,3
40	08	48,7	50,8
45	09	54,2	56,2
50	10	58,7	61,2
55	11	64,7	68,1
60	12	69,7	73,1
65	13	74,7	78,1
70	14	81,7	85
75	15	86,7	90
80	16	91,7	96,9
85	17	98,6	101,9
90	18	103,3	108,7
95	19	108,6	113,7
100	20	115,6	118,7
105	21	120,6	125,6
110	22	125,6	132,6
120	24	137,6	142,6
130	26	149,5	156,4
140	28	159,5	166,3
150	30	173,5	178,2
160	32	183,5	191,4
170	34	193,5	205,8
180	36	207,4	219,7
190	38	217,4	229,7
200	40	231,4	243,2
220	44	251,4	267,1
240	48	271,4	287
260	52	299,7	–
280	56	319,7	–
300	60	347	–
320	64	367	–
340	68	387,1	–
360	72	407	–

Bearing data – general

Boundary dimensions

The principal dimensions of SKF super-precision angular contact ball bearings are in accordance with ISO 15:2011:

- Boundary dimensions for bearings in the 719 .. D (SEB) series are in accordance with ISO dimension series 19.
- Boundary dimensions for bearings in the 70 .. D (EX) series are in accordance with ISO dimension series 10.

Chamfer dimensions

Minimum values for the chamfer dimensions in the radial direction (r_1, r_3) and the axial direction (r_2, r_4) are provided in the product tables, starting on **page 36**.

The values for the chamfers on the inner ring and thrust side of the outer ring are in accordance with ISO 15:2011. The values for the non-thrust side of the outer ring are in accordance with ISO 12044:1995, where applicable.

The appropriate maximum chamfer limits are in accordance with ISO 582:1995.

Tolerances

Bearings in the 719 .. D (SEB) and 70 .. D (EX) series are manufactured, standard, to P4A tolerance class. On request, bearings can be manufactured to the higher precision PA9A tolerance class.

The tolerance values are listed as follows:

- P4A (better than ABEC 7) tolerance class in **table 1**
- PA9A (better than ABEC 9) tolerance class in **table 2**

Table 1

Class P4A tolerances															
Inner ring		Δ_{dmp}	Δ_{ds}	V_{dp}	V_{dmp}	Δ_{Bs}	Δ_{B1s}	V_{Bs}	K_{ia}	S_d	S_{ia}				
over	incl.	high	low	high	low	high	low	high	low	high	low	max	max	max	max
mm		μm	μm	μm	μm	μm	μm	μm	μm	μm	μm	μm	μm	μm	μm
2,5	10	0	-4	0	-4	1,5	1	0	-40	0	-250	1,5	1,5	1,5	1,5
10	18	0	-4	0	-4	1,5	1	0	-80	0	-250	1,5	1,5	1,5	1,5
18	30	0	-5	0	-5	1,5	1	0	-120	0	-250	1,5	2,5	1,5	2,5
30	50	0	-6	0	-6	1,5	1	0	-120	0	-250	1,5	2,5	1,5	2,5
50	80	0	-7	0	-7	2	1,5	0	-150	0	-250	1,5	2,5	1,5	2,5
80	120	0	-8	0	-8	2,5	1,5	0	-200	0	-380	2,5	2,5	2,5	2,5
120	150	0	-10	0	-10	6	3	0	-250	0	-380	4	4	4	4
150	180	0	-10	0	-10	6	3	0	-250	0	-380	4	6	5	6
180	250	0	-12	0	-12	7	4	0	-300	0	-500	5	7	6	7
250	315	0	-13	0	-13	8	5	0	-350	0	-550	6	8	7	7
315	400	0	-16	0	-16	10	6	0	-400	0	-600	6	9	8	8
Outer ring		Δ_{Dmp}	Δ_{Ds}	V_{Dp}	V_{Dmp}	$\Delta_{Cs}, \Delta_{C1s}$	V_{Cs}	K_{ea}	S_D	S_{ea}					
over	incl.	high	low	high	low	max	max	max	max	max	max	max	max	max	max
mm		μm	μm	μm	μm	μm	μm	μm	μm	μm	μm	μm	μm	μm	μm
10	18	0	-4	0	-4	1,5	1	Values are identical to those for the inner ring of the same bearing ($\Delta_{Bs}, \Delta_{B1s}$)	1,5	1,5	1,5	1,5	1,5	1,5	1,5
18	30	0	-5	0	-5	2	1,5		1,5	1,5	1,5	1,5	1,5	1,5	1,5
30	50	0	-6	0	-6	2	1,5		1,5	1,5	2,5	1,5	1,5	2,5	2,5
50	80	0	-7	0	-7	2	1,5		1,5	1,5	4	1,5	1,5	4	4
80	120	0	-8	0	-8	2,5	1,5		1,5	1,5	5	2,5	2,5	5	5
120	150	0	-9	0	-9	4	1,5	1,5	2,5	5	2,5	2,5	5	5	
150	180	0	-10	0	-10	6	3	3	4	6	4	4	6	6	
180	250	0	-11	0	-11	6	4	4	5	8	5	5	8	8	
250	315	0	-13	0	-13	8	5	5	5	9	6	6	8	8	
315	400	0	-15	0	-15	9	6	6	7	10	8	8	10	10	
400	500	0	-20	0	-20	12	8	8	8	13	10	10	13	13	

The tolerance symbols used in these tables are listed together with their definitions in **table 3**, on **page 20**.

Bearing preload

A single super-precision angular contact ball bearing does not have any preload. Preload can only be obtained when one bearing is placed against another to provide location in the opposite direction.

Preload in sets of universally matchable bearings and matched bearing sets prior to mounting

Universally matchable bearings and matched bearing sets are manufactured so that when the bearings are placed against

each other, prior to mounting, a certain preload will result.

To meet the varying requirements with regard to rotational speed and rigidity, bearings in the 719 .. D (*SEB*) and 70 .. D (*EX*) series are produced to four different preload classes:

- class A, extra light preload
- class B, light preload
- class C, moderate preload
- class D, heavy preload

The preload level depends on the bearing series, the contact angle, the inner geometry and the size of the bearing, and applies to bearing sets with two bearings arranged back-to-back or face-to-face as listed in **table 4** on **page 21**.

Bearing sets consisting of three or four bearings, will have a heavier preload than

sets with two bearings. The preload for these bearing sets is obtained by multiplying the values listed in **table 4** on **page 21** by a factor of:

- 1,35 for TBT (*TD*) and TFT (*TF*) arrangements
- 1,6 for QBT (*3TD*) and QFT (*3TF*) arrangements
- 2 for QBC (*TDT*) and QFC (*TFT*) arrangements

Bearing sets with a special preload can be supplied on request. These bearing sets are identified by the designation suffix G followed by a number. The number is the mean preload value of the set expressed in daN. Special preload is not applicable for sets of universally matchable bearings consisting of three or more bearings (suffixes TG and QG).

Table 2

Class PA9A tolerances

Inner ring		Δ_{dmp}		Δ_{ds}		V_{dp}	V_{dmp}	Δ_{Bs}		Δ_{B1s}		V_{Bs}	K_{ia}	S_d	S_{ia}
over	incl.	high	low	high	low	max	max	high	low	high	low	max	max	max	max
mm		μm		μm		μm	μm	μm		μm		μm	μm	μm	μm
2,5	10	0	-2,5	0	-2,5	1,5	1	0	-40	0	-250	1,5	1,5	1,5	1,5
10	18	0	-2,5	0	-2,5	1,5	1	0	-80	0	-250	1,5	1,5	1,5	1,5
18	30	0	-2,5	0	-2,5	1,5	1	0	-120	0	-250	1,5	2,5	1,5	2,5
30	50	0	-2,5	0	-2,5	1,5	1	0	-120	0	-250	1,5	2,5	1,5	2,5
50	80	0	-4	0	-4	2	1,5	0	-150	0	-250	1,5	2,5	1,5	2,5
80	120	0	-5	0	-5	2,5	1,5	0	-200	0	-380	2,5	2,5	2,5	2,5
120	150	0	-7	0	-7	4	3	0	-250	0	-380	2,5	2,5	2,5	2,5
150	180	0	-7	0	-7	4	3	0	-250	0	-380	4	5	4	5
180	250	0	-8	0	-8	5	4	0	-300	0	-500	5	5	5	5
Outer ring		Δ_{Dmp}		Δ_{Ds}		V_{Dp}	V_{Dmp}	$\Delta_{Cs}, \Delta_{C1s}$		V_{Cs}	K_{ea}	S_D	S_{ea}		
over	incl.	high	low	high	low	max	max			max	max	max	max		
mm		μm		μm		μm	μm			μm	μm	μm	μm		
10	18	0	-2,5	0	-2,5	1,5	1	Values are identical to those for the inner ring of the same bearing ($\Delta_{Bs}, \Delta_{B1s}$)		1,5	1,5	1,5	1,5		
18	30	0	-4	0	-4	2	1,5			1,5	1,5	1,5	1,5		
30	50	0	-4	0	-4	2	1,5			1,5	2,5	1,5	2,5		
50	80	0	-4	0	-4	2	1,5			1,5	4	1,5	4		
80	120	0	-5	0	-5	2,5	1,5			2,5	5	2,5	5		
120	150	0	-5	0	-5	2,5	1,5			2,5	5	2,5	5		
150	180	0	-7	0	-7	4	3			2,5	5	2,5	5		
180	250	0	-8	0	-8	5	4			4	7	4	7		
250	315	0	-8	0	-8	5	4			5	7	5	7		
315	400	0	-10	0	-10	6	5			7	8	7	8		

Preload in mounted bearing sets

After mounting, sets of universally matchable bearings and matched bearing sets can have a heavier preload than the built-in preload, predetermined during manufacture. The increase in preload depends mainly on the actual tolerances for the bearing seats on the shaft and in the housing bore. An increase in preload can also be caused by deviations from the geometrical form of associated components such as cylindricity, perpendicularity or concentricity of the bearing seats.

During operation, an increase in preload can also be caused by:

- the rotational speed of the shaft, for constant position arrangements
- temperature gradients between the inner ring, outer ring and balls
- different coefficient of thermal expansion for the shaft and housing materials compared to the bearing steel

If the bearings are mounted with zero interference on a steel shaft and in a thick-walled steel or cast iron housing, preload can be determined with sufficient accuracy from

$$G_m = f f_1 f_2 f_{HC} G_{A,B,C,D}$$

where

- G_m = preload in the mounted bearing set [N]
- $G_{A,B,C,D}$ = built-in preload in the bearing set, prior to mounting (→ table 4) [N]
- f = a bearing factor dependent on the bearing series and size (→ table 5 on page 22)
- f_1 = a correction factor dependent on the contact angle (→ table 6 on page 23)
- f_2 = a correction factor dependent on the preload class (→ table 6 on page 23)
- f_{HC} = a correction factor for hybrid bearings (→ table 6 on page 23)

Table 3

Tolerance symbols

Tolerance symbol	Definition	Tolerance symbol	Definition
Bore diameter		Width	
d	Nominal bore diameter	B, C	Nominal width of inner ring and outer ring, respectively
d_s	Single bore diameter	B_s, C_s	Single width of inner ring and outer ring, respectively
d_{mp}	Mean bore diameter; arithmetical mean of the largest and smallest single bore diameters in one plane	B_{1s}, C_{1s}	Single width of inner ring and outer ring, respectively, of a bearing belonging to a matched set
Δ_{ds}	Deviation of a single bore diameter from the nominal ($\Delta_{ds} = d_s - d$)	Δ_{Bs}, Δ_{Cs}	Deviation of single inner ring width or single outer ring width from the nominal ($\Delta_{Bs} = B_s - B$; $\Delta_{Cs} = C_s - C$)
Δ_{dmp}	Deviation of the mean bore diameter from the nominal ($\Delta_{dmp} = d_{mp} - d$)	$\Delta_{B1s}, \Delta_{C1s}$	Deviation of single inner ring width or single outer ring width of a bearing belonging to a matched set from the nominal (not valid for universally matchable bearings) ($\Delta_{B1s} = B_{1s} - B$; $\Delta_{C1s} = C_{1s} - C$)
V_{dp}	Bore diameter variation; difference between the largest and smallest single bore diameters in one plane	V_{Bs}, V_{Cs}	Ring width variation; difference between the largest and smallest single widths of inner ring and of outer ring, respectively
V_{dmp}	Mean bore diameter variation; difference between the largest and smallest mean bore diameter		
Outside diameter		Running accuracy	
D	Nominal outside diameter	K_{ia}, K_{ea}	Radial runout of inner ring and outer ring, respectively, of assembled bearing
D_s	Single outside diameter	S_d	Side face runout with reference to bore (of inner ring)
D_{mp}	Mean outside diameter; arithmetical mean of the largest and smallest single outside diameters in one plane	S_D	Outside inclination variation; variation in inclination of outside cylindrical surface to outer ring side face
Δ_{Ds}	Deviation of a single outside diameter from the nominal ($\Delta_{Ds} = D_s - D$)	S_{ia}, S_{ea}	Axial runout of inner ring and outer ring, respectively, of assembled bearing
Δ_{Dmp}	Deviation of the mean outside diameter from the nominal ($\Delta_{Dmp} = D_{mp} - D$)		
V_{Dp}	Outside diameter variation; difference between the largest and smallest single outside diameters in one plane		
V_{Dmp}	Mean outside diameter variation; difference between the largest and smallest mean outside diameter		

Table 4

Axial preload of universally matchable bearings and matched bearing pairs, prior to mounting, arranged back-to-back or face-to-face

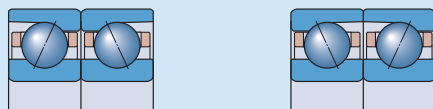

Bearing Bore diameter d	Size	Axial preload of bearings in the series ¹⁾				719 ACD (SEB 3) 719 ACD/HC (SEB/NS 3) for preload class				70 CD (EX 1) 70 CD/HC (EX/NS 1) for preload class				70 ACD (EX 3) 70 ACD/HC (EX/NS 3) for preload class			
		A	B	C	D	A	B	C	D	A	B	C	D	A	B	C	D
mm	–	N															
6	6	–	–	–	–	–	–	–	–	7	13	25	50	12	25	50	100
7	7	–	–	–	–	–	–	–	–	9	18	35	70	15	30	60	120
8	8	–	–	–	–	–	–	–	–	11	22	45	90	20	40	80	160
9	9	–	–	–	–	–	–	–	–	12	25	50	100	22	45	90	180
10	00	10	20	40	80	15	30	60	120	15	30	60	120	25	50	100	200
12	01	10	20	40	80	15	30	60	120	15	30	60	120	25	50	100	200
15	02	15	30	60	120	25	50	100	200	20	40	80	160	30	60	120	240
17	03	15	30	60	120	25	50	100	200	25	50	100	200	40	80	160	320
20	04	25	50	100	200	35	70	140	280	35	70	140	280	50	100	200	400
25	05	25	50	100	200	40	80	160	320	35	70	140	280	60	120	240	480
30	06	25	50	100	200	40	80	160	320	50	100	200	400	90	180	360	720
35	07	35	70	140	280	60	120	240	480	60	120	240	480	90	180	360	720
40	08	45	90	180	360	70	140	280	560	60	120	240	480	100	200	400	800
45	09	50	100	200	400	80	160	320	640	110	220	440	880	170	340	680	1 360
50	10	50	100	200	400	80	160	320	640	110	220	440	880	180	360	720	1 440
55	11	70	140	280	560	120	240	480	960	150	300	600	1 200	230	460	920	1 840
60	12	70	140	280	560	120	240	480	960	150	300	600	1 200	240	480	960	1 920
65	13	80	160	320	640	120	240	480	960	160	320	640	1 280	240	480	960	1 920
70	14	130	260	520	1 040	200	400	800	1 600	200	400	800	1 600	300	600	1 200	2 400
75	15	130	260	520	1 040	210	420	840	1 680	200	400	800	1 600	310	620	1 240	2 480
80	16	140	280	560	1 120	220	440	880	1 760	240	480	960	1 920	390	780	1 560	3 120
85	17	170	340	680	1 360	270	540	1 080	2 160	250	500	1 000	2 000	400	800	1 600	3 200
90	18	180	360	720	1 440	280	560	1 120	2 240	300	600	1 200	2 400	460	920	1 840	3 680
95	19	190	380	760	1 520	290	580	1 160	2 320	310	620	1 240	2 480	480	960	1 920	3 840
100	20	230	460	920	1 840	360	720	1 440	2 880	310	620	1 240	2 480	500	1 000	2 000	4 000
105	21	230	460	920	1 840	360	720	1 440	2 880	360	720	1 440	2 880	560	1 120	2 240	4 480
110	22	230	460	920	1 840	370	740	1 480	2 960	420	840	1 680	3 360	650	1 300	2 600	5 200
120	24	290	580	1 160	2 320	450	900	1 800	3 600	430	860	1 720	3 440	690	1 380	2 760	5 520
130	26	350	700	1 400	2 800	540	1 080	2 160	4 320	560	1 120	2 240	4 480	900	1 800	3 600	7 200
140	28	360	720	1 440	2 880	560	1 120	2 240	4 480	570	1 140	2 280	4 560	900	1 800	3 600	7 200
150	30	470	940	1 880	3 760	740	1 480	2 960	5 920	650	1 300	2 600	5 200	1 000	2 000	4 000	8 000
160	32	490	980	1 960	3 920	800	1 600	3 200	6 400	730	1 460	2 920	5 840	1 150	2 300	4 600	9 200
170	34	500	1 000	2 000	4 000	800	1 600	3 200	6 400	800	1 600	3 200	6 400	1 250	2 500	5 000	10 000
180	36	630	1 260	2 520	5 040	1 000	2 000	4 000	8 000	900	1 800	3 600	7 200	1 450	2 900	5 800	11 600
190	38	640	1 280	2 560	5 120	1 000	2 000	4 000	8 000	950	1 900	3 800	7 600	1 450	2 900	5 800	11 600
200	40	800	1 600	3 200	6 400	1 250	2 500	5 000	10 000	1 100	2 200	4 400	8 800	1 750	3 500	7 000	14 000
220	44	850	1 700	3 400	6 800	1 300	2 600	5 200	10 400	1 250	2 500	5 000	10 000	2 000	4 000	8 000	16 000
240	48	860	1 720	3 440	6 880	1 350	2 700	5 400	10 800	1 300	2 600	5 200	10 400	2 050	4 100	8 200	16 400
260	52	1 050	2 100	4 200	8 400	1 650	3 300	6 600	13 200	–	–	–	–	–	–	–	–
280	56	1 090	2 180	4 360	8 720	1 700	3 400	6 800	13 600	–	–	–	–	–	–	–	–
300	60	1 400	2 800	5 600	11 200	2 200	4 400	8 800	17 600	–	–	–	–	–	–	–	–
320	64	1 400	2 800	5 600	11 200	2 200	4 400	8 800	17 600	–	–	–	–	–	–	–	–
340	68	1 460	2 920	5 840	11 680	2 300	4 600	9 200	18 400	–	–	–	–	–	–	–	–
360	72	1 460	2 920	5 840	11 680	2 300	4 600	9 200	18 400	–	–	–	–	–	–	–	–

¹⁾ Data is also applicable to sealed bearings.

Considerably tighter fits may be necessary, for example, for very high speed spindles, where centrifugal forces can loosen the inner ring from its seat on the shaft. These bearing arrangements must be carefully evaluated.

Preload with constant force

In precision, high-speed applications, a constant and uniform preload is important. To maintain the proper preload, calibrated linear springs can be used between one bearing outer ring and its housing shoulder (→ fig. 1). With springs, the kinematic behaviour of the bearing will not influence preload under normal operating conditions. Note, however, that a spring-loaded bearing arrangement has a lower degree of rigidity than an arrangement using axial displacement to set the preload.

Preload by axial displacement

Rigidity and precise axial guidance are critical parameters in bearing arrangements, especially when alternating axial forces occur. As a result, the preload in the bearings is usually obtained by adjusting the bearing rings relative to each other in the axial direction. This preload method offers significant benefits in terms of system rigidity. However, depending on the bearing series, contact angle and ball material, preload increases considerably with rotational speed.

Universally matchable bearings and matched bearing sets are manufactured so that when mounted properly, they will attain their predetermined axial displacement and consequently the proper preload. With single bearings, precision-matched spacer rings must be used.

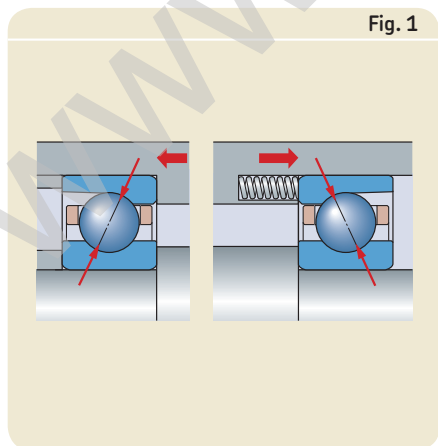

Fig. 1

Table 5

Bearing factor f for calculating the preload in mounted bearing sets

Bearing Bore diameter d	Size	Bearing factor f for bearings in the series ¹⁾	
		719 .. D (SEB)	70 .. D (EX)
mm	–	–	–
6	6	–	1,01
7	7	–	1,02
8	8	–	1,02
9	9	–	1,03
10	00	1,03	1,03
12	01	1,04	1,03
15	02	1,05	1,03
17	03	1,05	1,04
20	04	1,05	1,03
25	05	1,07	1,05
30	06	1,08	1,06
35	07	1,1	1,06
40	08	1,09	1,06
45	09	1,11	1,09
50	10	1,13	1,11
55	11	1,15	1,1
60	12	1,17	1,12
65	13	1,2	1,13
70	14	1,19	1,12
75	15	1,21	1,14
80	16	1,24	1,13
85	17	1,2	1,15
90	18	1,23	1,14
95	19	1,26	1,15
100	20	1,23	1,16
105	21	1,25	1,15
110	22	1,26	1,14
120	24	1,26	1,17
130	26	1,25	1,15
140	28	1,29	1,16
150	30	1,24	1,16
160	32	1,27	1,16
170	34	1,3	1,14
180	36	1,25	1,13
190	38	1,27	1,14
200	40	1,23	1,14
220	44	1,28	1,13
240	48	1,32	1,15
260	52	1,24	–
280	56	1,27	–
300	60	1,22	–
320	64	1,24	–
340	68	1,27	–
360	72	1,29	–

¹⁾ Data is also applicable to sealed bearings.

Adjusting preload with spacer rings

By placing precision-matched spacer rings between two bearings, it is possible to increase or decrease preload. Precision spacer rings can also be used to:

- increase system rigidity
- create a sufficiently large grease reservoir between two bearings
- create a space for oil-air lubrication nozzles

It is possible to adjust preload in a bearing set by grinding the side face of the inner or outer spacer ring. **Table 7** provides information about which of the equal-width spacer ring side faces must be ground and what effect it will have. Guideline values for the requisite overall width reduction of the spacer rings are listed in **table 8** on **page 24**.

To achieve maximum bearing performance, the spacer rings must not deform under load. They should be made of high-grade steel that can be hardened to between 45 and 60 HRC. Particular importance must be given to the plane parallelism of the side face surfaces, where the permissible shape deviation must not exceed 2 µm.

Effect of rotational speed on preload

Using strain gauges, SKF has determined that there is a marked increase in preload at very high speeds. This is mainly attributable to the heavy centrifugal forces on the balls causing them to change their position within the bearing. When compared to an all-steel bearing, a hybrid bearing can attain much higher rotational speeds without significantly increasing preload. This is due to the lower mass of the balls.

Bearing axial stiffness

Axial stiffness depends on the deformation of the bearing under load and can be expressed as a ratio of the load to bearing resilience. However, since the relationship between resilience and load is not linear, only guideline values can be provided (→ **table 9, page 25**). These values apply to mounted bearing pairs under static conditions and subjected to moderate loads.

Exact values can be calculated using advanced computer methods. For additional information, contact the SKF application engineering service.

Bearing sets comprising three or four bearings can provide a higher degree of axial stiffness than sets with two bearings. The axial stiffness for these sets can be calculated by multiplying the values listed in **table 9, page 25** by a factor dependent on the bearing arrangement:

- 1,45 for TBT (*TD*) and TFT (*TF*) arrangements
- 1,8 for QBT (*3TD*) and QFT (*3TF*) arrangements
- 2 for QBC (*TDT*) and QFC (*TFT*) arrangements

For hybrid bearings, the axial stiffness can be calculated in the same way as for all-steel bearings. However, the calculated value should then be multiplied by a factor of 1,11 (for all arrangements and preload classes).

Table 6

Correction factors for calculating the preload in mounted bearing sets

Bearing series ¹⁾	Correction factors					f_{HC}
	f_1	f_2	for preload class			
			A	B	C	
719 CD (<i>SEB 1</i>)	1	1	1,04	1,09	1,15	1
719 ACD (<i>SEB 3</i>)	0,98	1	1,04	1,08	1,14	1
719 CD/HC (<i>SEB /NS 1</i>)	1	1	1,07	1,12	1,18	1,04
719 ACD/HC (<i>SEB /NS 3</i>)	0,98	1	1,07	1,12	1,17	1,04
70 CD (<i>EX 1</i>)	1	1	1,02	1,05	1,09	1
70 ACD (<i>EX 3</i>)	0,99	1	1,02	1,05	1,08	1
70 CD/HC (<i>EX /NS 1</i>)	1	1	1,02	1,05	1,09	1,02
70 ACD/HC (<i>EX /NS 3</i>)	0,99	1	1,02	1,05	1,08	1,02

¹⁾ Data is also applicable to sealed bearings.

Table 7

Guidelines for spacer ring modification

Preload change of a bearing set	Width reduction Value	Requisite spacer ring between bearings arranged	
		back-to-back	face-to-face
Increasing the preload			
from A to B	a	inner	outer
from B to C	b	inner	outer
from C to D	c	inner	outer
from A to C	a + b	inner	outer
from A to D	a + b + c	inner	outer
Decreasing the preload			
from B to A	a	outer	inner
from C to B	b	outer	inner
from D to C	c	outer	inner
from C to A	a + b	outer	inner
from D to A	a + b + c	outer	inner

Table 8

Guideline values for spacer ring width reduction

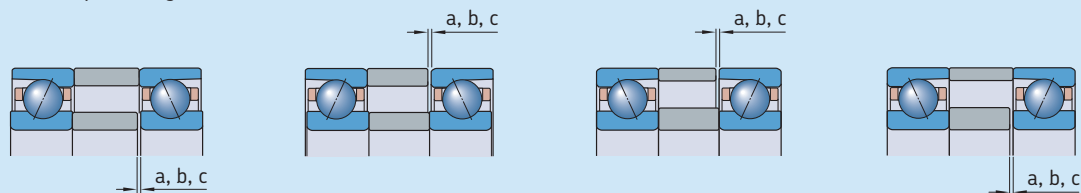
Increasing the preload
(back-to-back arrangement)Decreasing the preload
(back-to-back arrangement)Increasing the preload
(face-to-face arrangement)Decreasing the preload
(face-to-face arrangement)

Bearing Bore diameter d	Size	Requisite spacer ring width reduction for bearings in the series ¹⁾											
		719 CD (SEB 1)			719 ACD (SEB 3)			70 CD (EX 1)			70 ACD (EX 3)		
		a	b	c	a	b	c	a	b	c	a	b	c
mm	–	µm											
6	6	–	–	–	–	–	–	3	4	7	2	4	5
7	7	–	–	–	–	–	–	4	5	8	2	4	6
8	8	–	–	–	–	–	–	4	6	8	3	4	6
9	9	–	–	–	–	–	–	4	6	8	3	4	6
10	00	3	4	6	2	3	5	4	6	9	3	4	7
12	01	3	4	6	2	3	5	4	6	9	3	4	7
15	02	4	5	8	2	4	6	4	6	9	3	4	7
17	03	4	5	8	2	4	6	5	7	10	3	5	7
20	04	4	6	9	3	4	6	6	8	12	3	5	8
25	05	4	6	9	3	4	6	6	8	12	3	5	8
30	06	4	6	9	3	4	6	6	9	14	4	7	10
35	07	4	7	10	3	5	7	6	10	14	4	7	10
40	08	5	7	11	3	5	8	6	10	14	4	7	10
45	09	5	8	11	3	5	8	8	11	16	5	8	12
50	10	5	8	11	3	5	8	8	11	16	5	8	12
55	11	6	9	14	4	7	10	9	13	19	6	9	14
60	12	6	9	14	4	7	10	9	13	19	6	9	14
65	13	6	10	15	4	7	10	9	13	19	6	9	14
70	14	7	11	16	5	8	12	10	15	22	6	10	16
75	15	7	11	16	5	8	12	10	15	22	6	10	16
80	16	7	11	17	5	8	12	11	16	23	7	11	17
85	17	8	13	19	6	9	14	11	16	24	7	11	17
90	18	9	13	19	6	9	14	12	18	26	8	12	19
95	19	9	13	20	6	9	14	12	18	26	8	12	19
100	20	10	15	22	6	10	16	12	18	26	8	12	19
105	21	10	15	22	6	10	16	13	19	29	8	13	21
110	22	10	15	22	6	10	16	14	21	31	9	15	23
120	24	11	16	24	7	11	18	14	21	31	9	15	23
130	26	12	18	27	8	12	19	16	24	35	11	17	26
140	28	12	18	27	8	12	20	16	24	36	11	17	26
150	30	14	21	32	9	15	23	17	26	38	11	17	27
160	32	14	22	32	9	15	24	18	27	40	12	19	29
170	34	14	22	33	9	15	24	18	28	41	12	19	29
180	36	16	24	36	10	17	27	20	30	44	13	20	32
190	38	16	25	37	10	17	27	20	30	45	13	20	32
200	40	18	28	41	12	19	30	22	33	49	14	22	35
220	44	18	28	42	12	19	30	23	35	52	15	24	37
240	48	18	28	42	12	20	31	23	35	53	15	24	38
260	52	19	30	45	13	21	33	–	–	–	–	–	–
280	56	19	30	45	13	21	34	–	–	–	–	–	–
300	60	23	36	54	15	24	38	–	–	–	–	–	–
320	64	23	36	54	15	24	38	–	–	–	–	–	–
340	68	23	36	54	15	24	39	–	–	–	–	–	–
360	72	23	36	54	15	24	39	–	–	–	–	–	–

¹⁾ Data is also applicable to sealed bearings.

Table 9

Static axial stiffness for bearing pairs arranged back-to-back or face-to-face

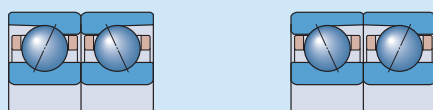

Bearing Bore diameter d	Size	Static axial stiffness of all-steel bearings in the series ¹⁾															
		719 CD (SEB 1) for preload class				719 ACD (SEB 3) for preload class				70 CD (EX 1) for preload class				70 ACD (EX 3) for preload class			
		A	B	C	D	A	B	C	D	A	B	C	D	A	B	C	D
mm	–	N/μm															
6	6	–	–	–	–	–	–	–	–	8	10	13	18	19	26	33	44
7	7	–	–	–	–	–	–	–	–	9	12	16	22	22	28	37	49
8	8	–	–	–	–	–	–	–	–	10	14	19	26	27	35	45	60
9	9	–	–	–	–	–	–	–	–	11	15	21	29	30	39	51	67
10	00	12	16	22	32	29	38	49	65	13	17	23	33	32	41	54	71
12	01	13	17	23	33	31	39	52	69	14	18	25	35	34	44	57	76
15	02	16	21	29	41	40	51	67	88	17	23	31	44	41	53	69	92
17	03	16	22	30	43	42	54	70	93	19	26	35	50	48	62	81	107
20	04	22	29	40	56	51	65	85	113	23	30	42	59	54	69	90	120
25	05	24	32	44	62	60	78	101	134	25	33	46	64	64	83	108	143
30	06	26	35	47	67	65	83	109	145	30	40	55	77	79	102	133	176
35	07	32	42	58	82	81	105	137	183	36	47	64	90	86	110	144	190
40	08	36	48	66	93	89	115	151	199	38	51	69	96	96	124	162	214
45	09	40	53	73	103	100	129	168	225	56	76	107	155	132	173	229	309
50	10	43	57	78	110	105	137	180	240	58	79	111	161	141	184	244	331
55	11	49	65	89	126	124	161	211	282	67	91	128	186	159	207	275	372
60	12	50	67	92	130	128	166	218	292	70	95	133	193	168	219	291	393
65	13	56	75	104	148	136	176	232	311	74	101	143	207	174	227	302	409
70	14	76	104	147	215	180	235	314	428	81	111	156	227	191	249	330	447
75	15	80	110	156	228	194	255	340	464	84	115	162	235	200	262	347	471
80	16	85	117	167	246	204	267	358	490	92	125	175	254	223	291	386	523
85	17	89	122	172	251	214	281	374	509	97	132	185	268	233	304	405	549
90	18	94	129	183	268	224	293	392	536	103	141	198	287	245	321	425	575
95	19	101	139	198	291	240	315	420	576	108	148	208	302	258	337	448	607
100	20	107	147	209	306	255	336	449	613	112	153	215	312	270	355	472	640
105	21	110	151	215	316	263	346	463	633	117	159	223	324	279	365	484	655
110	22	113	156	221	325	274	359	482	661	122	166	232	337	290	379	503	681
120	24	127	174	246	361	302	396	529	724	131	179	251	364	318	416	552	749
130	26	137	188	266	391	325	427	570	780	145	198	277	400	353	460	610	826
140	28	146	201	286	420	348	457	614	841	151	206	289	418	364	477	633	856
150	30	154	211	297	435	370	485	648	882	163	221	310	449	388	506	671	909
160	32	166	227	321	471	402	530	710	970	171	233	327	472	414	540	717	968
170	34	171	236	334	493	415	546	731	1 002	179	243	339	488	433	563	744	1 003
180	36	183	250	353	516	442	581	774	1 055	186	251	349	501	456	593	782	1 052
190	38	189	260	367	538	455	599	798	1 090	196	266	370	532	471	613	809	1 088
200	40	202	275	387	565	484	635	845	1 148	208	280	389	556	509	660	871	1 170
220	44	224	306	434	635	533	699	934	1 275	222	300	415	592	546	710	935	1 254
240	48	237	325	461	678	584	767	1 029	1 412	234	316	438	627	571	743	979	1 315
260	52	249	339	475	688	616	807	1 071	1 455	–	–	–	–	–	–	–	–
280	56	266	363	509	741	659	867	1 154	1 572	–	–	–	–	–	–	–	–
300	60	272	369	514	741	663	866	1 146	1 548	–	–	–	–	–	–	–	–
320	64	281	380	530	765	683	892	1 183	1 599	–	–	–	–	–	–	–	–
340	68	300	408	571	827	739	967	1 284	1 742	–	–	–	–	–	–	–	–
360	72	309	420	588	853	754	987	1 311	1 779	–	–	–	–	–	–	–	–

¹⁾ Data is also applicable to sealed bearings.

Fitting and clamping bearing rings

Super-precision angular contact ball bearings are typically located axially on shafts or in housings with either precision lock nuts (→ fig. 2) or end caps. These components require high geometrical precision and good mechanical strength to provide reliable locking.

The tightening torque M_t for precision lock nuts or end cap bolts, must be sufficient to prevent relative movement of adjacent components, maintain the position of the bearings without deformation, and minimize material fatigue.

Fig. 2

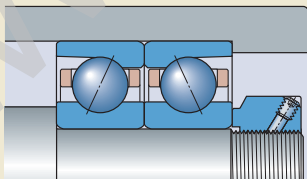

Table 10

Minimum axial clamping force and axial fitting force for precision lock nuts and end caps

Bearing Bore diameter d	Size	Minimum axial clamping force for bearings in the series ¹⁾		Axial fitting force for bearings in the series ¹⁾	
		719 .. D (SEB) F_s	70 .. D (EX)	719 .. D (SEB) F_c	70 .. D (EX)
mm	–	N		N	
6	6	–	260	–	430
7	7	–	310	–	410
8	8	–	450	–	490
9	9	–	600	–	490
10	00	500	600	280	500
12	01	600	700	280	470
15	02	650	1 000	280	490
17	03	750	1 000	280	490
20	04	1 300	1 600	400	650
25	05	1 600	2 000	340	550
30	06	1 900	2 500	300	550
35	07	2 600	3 300	440	750
40	08	3 100	4 100	500	750
45	09	3 800	4 500	480	750
50	10	3 100	5 000	430	650
55	11	4 100	6 000	430	800
60	12	4 500	6 500	400	750
65	13	4 800	7 000	370	700
70	14	6 500	8 500	500	800
75	15	6 500	9 000	480	750
80	16	7 000	11 000	650	1 200
85	17	9 000	11 000	900	1 400
90	18	9 500	14 000	850	1 400
95	19	10 000	14 000	850	1 500
100	20	12 000	15 000	1 000	1 400
105	21	12 500	17 000	900	1 600
110	22	13 000	20 000	900	1 800
120	24	16 000	22 000	1 200	1 900
130	26	23 000	27 000	1 300	2 700
140	28	24 000	29 000	1 300	2 500
150	30	27 000	34 000	1 800	2 700
160	32	28 000	38 000	1 700	2 900
170	34	30 000	51 000	1 600	3 500
180	36	37 000	59 000	2 200	4 000
190	38	39 000	62 000	2 600	4 500
200	40	48 000	66 000	3 200	5 500
220	44	52 000	79 000	2 900	6 000
240	48	57 000	86 000	2 700	5 500
260	52	77 000	–	4 000	–
280	56	83 000	–	4 000	–
300	60	107 000	–	5 300	–
320	64	114 000	–	5 700	–
340	68	120 000	–	6 000	–
360	72	127 000	–	6 200	–

¹⁾ Data is also applicable to sealed bearings.

Table 11

Factor K for calculating the tightening torque

Nominal thread diameter ¹⁾	Factor K for precision lock nuts	end cap bolts
–	–	–
M 4	–	0,8
M 5	–	1
M 6	–	1,2
M 8	–	1,6
M 10	1,4	2
M 12	1,6	2,4
M 14	1,9	2,7
M 15	2	2,9
M 16	2,1	3,1
M 17	2,2	–
M 20	2,6	–
M 25	3,2	–
M 30	3,9	–
M 35	4,5	–
M 40	5,1	–
M 45	5,8	–
M 50	6,4	–
M 55	7	–
M 60	7,6	–
M 65	8,1	–
M 70	9	–
M 75	9,6	–
M 80	10	–
M 85	11	–
M 90	11	–
M 95	12	–
M 100	12	–
M 105	13	–
M 110	14	–
M 120	15	–
M 130	16	–
M 140	17	–
M 150	18	–
M 160	19	–
M 170	21	–
M 180	22	–
M 190	23	–
M 200	24	–
M 220	26	–
M 240	27	–
M 260	29	–
M 280	32	–
M 300	34	–
M 320	36	–
M 340	38	–
M 360	40	–

¹⁾ Applicable for fine threads only

Calculating the tightening torque M_t

It is difficult to accurately calculate the tightening torque M_t for a precision lock nut or the bolts in an end cap. The following formulas can be used to do the calculations, but the results should be verified during operation.

The axial clamping force for a precision lock nut or the bolts in an end cap is

$$P_a = F_s + (N_{cp}F_c) + G_{A,B,C,D}$$

The tightening torque for a precision lock nut is

$$M_t = K P_a \\ = K [F_s + (N_{cp}F_c) + G_{A,B,C,D}]$$

The tightening torque for end cap bolts is

$$M_t = \frac{K P_a}{N_b}$$

$$M_t = \frac{K [F_s + (N_{cp}F_c) + G_{A,B,C,D}]}{N_b}$$

where

M_t = tightening torque [Nmm]

P_a = axial clamping force [N]

F_s = minimum axial clamping force
(→ table 10) [N]

F_c = axial fitting force (→ table 10) [N]

$G_{A,B,C,D}$ = built-in bearing preload, prior to mounting (→ table 4 on page 21) [N]

N_{cp} = the number of preloaded bearings

N_b = the number of end cap bolts

K = a calculation factor dependent on the thread (→ table 11)

Load carrying capacity of bearing sets

The values listed in the product tables, starting on **page 36**, for the basic dynamic load rating C , the basic static load rating C_0 and the fatigue load limit P_u apply to single bearings. For bearing sets, the values for single bearings should be multiplied by a calculation factor in **table 12**.

Equivalent bearing loads

When determining the equivalent bearing load for preloaded bearings, the preload must be taken into account. Depending on the operating conditions, the requisite axial component of the bearing load F_a for a bearing pair arranged back-to-back or face-to-face can be approximated using the following equations.

For bearing pairs under radial load and mounted with an interference fit

$$F_a = G_m$$

For bearing pairs under radial load and preloaded by springs

$$F_a = G_{A,B,C,D}$$

For bearing pairs under axial load and mounted with an interference fit

$$F_a = G_m + 0,67 K_a \quad \text{for } K_a \leq 3 G_m$$

$$F_a = K_a \quad \text{for } K_a > 3 G_m$$

For bearing pairs under axial load and preloaded by springs

$$F_a = G_{A,B,C,D} + K_a$$

where

- F_a = axial component of the load [N]
- $G_{A,B,C,D}$ = built-in preload of the bearing pair, prior to mounting (\rightarrow **table 4** on **page 21**) [N]
- G_m = preload in the mounted bearing pair (\rightarrow *Preload in mounted bearing sets*, **page 20**) [N]
- K_a = external axial force acting on a single bearing [N]

Table 12

Calculation factors for load carrying capacities of bearing sets

Number of bearings	Calculation factor for		
	C	C_0	P_u
2	1,62	2	2
3	2,16	3	3
4	2,64	4	4

Table 13

Calculation factors for single bearings and bearings paired in tandem

$f_0 F_a / C_0$	Calculation factors			
	e	X	Y	Y_0
For 15° contact angle designation suffix CD (1)				
$\leq 0,178$	0,38	0,44	1,47	0,46
0,357	0,4	0,44	1,4	0,46
0,714	0,43	0,44	1,3	0,46
1,07	0,46	0,44	1,23	0,46
1,43	0,47	0,44	1,19	0,46
2,14	0,5	0,44	1,12	0,46
3,57	0,55	0,44	1,02	0,46
$\geq 5,35$	0,56	0,44	1	0,46
For 25° contact angle designation suffix ACD (3)				
–	0,68	0,41	0,87	0,38

Equivalent dynamic bearing load

For single bearings and bearings paired in tandem

$$P = F_r \quad \text{for } F_a/F_r \leq e$$

$$P = XF_r + YF_a \quad \text{for } F_a/F_r > e$$

For bearing pairs, arranged back-to-back or face-to-face

$$P = F_r + Y_1F_a \quad \text{for } F_a/F_r \leq e$$

$$P = XF_r + Y_2F_a \quad \text{for } F_a/F_r > e$$

where

P = equivalent dynamic load of the bearing set [kN]

F_r = radial component of the load acting on the bearing set [kN]

F_a = axial component of the load acting on the bearing set [kN]

The values for the calculation factors e , X , Y , Y_1 and Y_2 depend on the bearing contact angle and are listed in **tables 13** and **14**. For bearings with a 15° contact angle, the factors also depend on the relationship f_0F_a/C_0 where f_0 is the calculation factor and C_0 is the basic static load rating, both of which are listed in the product tables, starting on **page 36**.

Equivalent static bearing load

For single bearings and bearings paired in tandem

$$P_0 = 0,5 F_r + Y_0F_a$$

For bearing pairs, arranged back-to-back or face-to-face

$$P_0 = F_r + Y_0F_a$$

where

P_0 = equivalent static load of the bearing set [kN]

F_r = radial component of the load acting on the bearing set [kN]

F_a = axial component of the load acting on the bearing set [kN]

If $P_0 < F_r$, $P_0 = F_r$ should be used. The values for the calculation factor Y_0 depend on the bearing contact angle and are listed in **tables 13** and **14**.

Table 14

Calculation factors for bearing pairs arranged back-to-back or face-to-face

2 f_0F_a/C_0	Calculation factors				
	e	X	Y_1	Y_2	Y_0
For 15° contact angle designation suffix CD (1)					
≤ 0,178	0,38	0,72	1,65	2,39	0,92
0,357	0,4	0,72	1,57	2,28	0,92
0,714	0,43	0,72	1,46	2,11	0,92
1,07	0,46	0,72	1,38	2	0,92
1,43	0,47	0,72	1,34	1,93	0,92
2,14	0,5	0,72	1,26	1,82	0,92
3,57	0,55	0,72	1,14	1,66	0,92
≥ 5,35	0,56	0,72	1,12	1,63	0,92
For 25° contact angle designation suffix ACD (3)					
–	0,68	0,67	0,92	1,41	0,76

Attainable speeds

The attainable speeds listed in the product tables, starting on **page 36**, should be regarded as guideline values. They are valid for single bearings under light load ($P \leq 0,05 C$) that are lightly preloaded with springs. In addition, good heat dissipation from the bearing arrangement is a pre-requisite. As there is no friction generated at the seal lip, the attainable speed of a sealed bearing is equivalent to a comparably sized open bearing.

The values provided for oil lubrication apply to the oil-air lubrication method and should be reduced if other oil lubrication methods are used. The values provided for grease lubrication are maximum values that can be attained with sealed bearings or open bearings with good lubricating grease that has a low consistency and low viscosity.

Sealed bearings in the S719 .. D (SEB .. /S) and S70 .. D (EX .. /S) series are designed for high-speed operation i.e. for a speed factor A up to approximately 1 400 000 mm/min.

If single bearings are adjusted against each other with heavier preload or if bearing sets are used, the attainable speeds listed in the product tables, starting on **page 36**, should be reduced, i.e. the values should be multiplied by a reduction factor. Values for this reduction factor, which depend on the bearing arrangement and preload class, are listed in **table 15**.

If the rotational speed obtained is not sufficient for the application, precision-matched spacer rings in the bearing set can be used to increase the speed capability.

Cages

Depending on its size, bearings in the 719 .. D (SEB) and 70 .. D (EX) series are equipped with either a phenolic resin or brass cage as follows:

- Bearings with a bore diameter $d = 6$ to 280 mm are equipped with a one-piece outer ring shoulder-guided cage made of fabric reinforced phenolic resin (→ **fig. 3**), no designation suffix (CE).
- Bearings with a bore diameter $d = 300$ to 360 mm are equipped with a one-piece outer ring shoulder-guided machined brass cage, designation suffix MA (LE).

Phenolic resin cages can withstand temperatures up to 120 °C, brass cages up to 250 °C.

The most common bearings are also available, on request, with a glass fibre reinforced injection moulded polyether-etherketone (PEEK) cage (→ **fig. 3**), designation suffix TNHA (KE), which can withstand temperatures up to 150 °C. Bearings that are available with a PEEK cage are marked in the product tables, starting on **page 36**, by a footnote.

Seals

The integral seals in sealed S719 .. D (SEB .. /S) and S70 .. D (EX .. /S) series bearings are designed for a speed factor A up to approximately 1 400 000 mm/min. The permissible operating temperature range of the seals is -25 to +100 °C and up to 120 °C for brief periods.

Table 15

Speed reduction factors for bearing sets

Number of bearings	Arrangement	Designation suffix for matched sets	Speed reduction factor for preload class			
			A	B	C	D
2	Back-to-back	DB (DD)	0,81	0,75	0,65	0,4
	Face-to-face	DF (FF)	0,77	0,72	0,61	0,36
3	Back-to-back and tandem	TBT (TD)	0,7	0,63	0,49	0,25
	Face-to-face and tandem	TFT (TF)	0,63	0,56	0,42	0,17
4	Tandem back-to-back	QBC (TDT)	0,64	0,6	0,53	0,32
	Tandem face-to-face	QFC (TFT)	0,62	0,58	0,48	0,27

Note: For spring-loaded tandem sets, designation suffix DT (T), a speed reduction factor of 0,9 should be applied.

Materials

The rings and balls of all-steel bearings in the 719 .. D (*SEB*) and 70 .. D (*EX*) series are made from SKF Grade 3 steel, in accordance with ISO 683-17:1999. Balls of hybrid bearings are made of bearing grade silicon nitride Si_3N_4 . The rings of sealed hybrid bearings with a designation prefix SV (*suffix /S/XN*) are made from NitroMax, a high-nitrogen stainless steel.

The integral seals in sealed bearings are made of an oil- and wear-resistant acrylonitrile-butadiene rubber (NBR) and are reinforced with sheet steel. The O-rings of bearings for direct oil lubrication with a designation suffix L (*GH*) are also made of acrylonitrile-butadiene rubber.

Heat treatment

All SKF super-precision bearings undergo a special heat treatment to achieve a good balance between hardness and dimensional stability. The hardness of the rings and rolling elements is optimized for wear-resistance. The rings of bearings in the 719 .. D (*SEB*) and 70 .. D (*EX*) series are heat stabilized to accommodate temperatures up to 150 °C.



Fig. 3

Markings on bearings and bearing sets

Each SKF bearing in the 719 .. D (SEB) and 70 .. D (EX) series has various markings on the external surfaces of the rings (→ fig. 4):

- 1 SKF trademark
- 2 Complete designation of the bearing
- 3 Country of manufacture
- 4 Date of manufacture, coded
- 5 Deviation of the mean outside diameter Δ_{Dm} [μm] and position of the maximum eccentricity of the outer ring
- 6 Deviation of the mean bore diameter Δ_{dm} [μm] and position of the maximum eccentricity of the inner ring
- 7 Thrust face mark, punched
- 8 Serial number (bearing sets only)
- 9 "V-shaped" marking (matched bearing sets only)

Sealed bearings are marked in a similar way.

"V-shaped" marking

A "V-shaped" marking on the outside surface of the outer rings of matched bearing sets indicates how the bearings should be mounted to obtain the proper preload in the set. The marking also indicates how the bearing set should be mounted in relation to the axial load. The "V-shaped" marking should point in the direction in which the axial load will act on the inner ring (→ fig. 5). In applications where there are axial loads in both directions, the "V-shaped" marking should point toward the greater of the two loads.

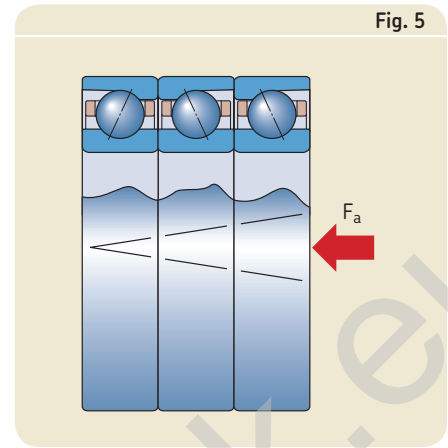

Fig. 5



Fig. 4

Packaging

Super-precision bearings are distributed in new SKF illustrated boxes (→ **fig. 6**). An instruction sheet, with information about mounting bearing sets, is supplied in each box.

Designation system

The designations for SKF bearings in the 719 .. D (*SEB*) and 70 .. D (*EX*) series are provided in **table 16** on **page 34** together with their definitions.



Designation system for SKF super-precision angular contact ball bearings in the 719 .. D (SEB) and 70 .. D (EX) series

Single bearing: 71922 CDGBTNHA/PA9A		719	22	CD	GB	TNHA /		PA9A	L		
Matched bearing set: S7010 ACD/HCP4AQBCC	S	70	10	ACD		/	HC	P4A		QBC	C
	Variant prefix	Series	Size	Contact angle and design	Execution and preload (single bearing)	Cage	Ball material	Tolerance class	Lubrication feature	Arrangement	Preload

Variant (prefix)

- Open bearing (no designation prefix)
- S Sealed bearing
- V Bearing with NitroMax steel rings and bearing grade silicon nitride Si₃N₄ balls

Bearing series

- 719 In accordance with ISO dimension series 19
- 70 In accordance with ISO dimension series 10

Bearing size

- 6 6 mm bore diameter¹⁾
- 7 7 mm bore diameter¹⁾
- 8 8 mm bore diameter¹⁾
- 9 9 mm bore diameter¹⁾
- 00 10 mm bore diameter
- 01 12 mm bore diameter
- 02 15 mm bore diameter
- 03 17 mm bore diameter
- 04 (x5) 20 mm bore diameter
- to
- 72 (x5) 360 mm bore diameter²⁾

Contact angle and internal design

- CD 15° contact angle, high-capacity basic design
- ACD 25° contact angle, high-capacity basic design

Single bearing – execution and preload

- Single bearing (no designation suffix)
- GA Single, universally matchable, for extra light preload
- GB Single, universally matchable, for light preload
- GC Single, universally matchable, for moderate preload
- GD Single, universally matchable, for heavy preload

Cage

- Fabric reinforced phenolic resin, outer ring centred (no designation suffix)
- MA Machined brass, outer ring centred
- TNHA Glass fibre reinforced PEEK, outer ring centred

Ball material

- Carbon chromium steel (no designation suffix)
- HC Bearing grade silicon nitride Si₃N₄ (hybrid bearings)

Tolerance class

- P4A Dimensional accuracy in accordance with ISO tolerance class 4, running accuracy better than ISO tolerance class 4
- PA9A Dimensional and running accuracy better than ABMA tolerance class ABEC 9

Lubrication feature

- H Two lubrication holes in the outer ring for direct oil lubrication
- H1 Two lubrication holes in the outer ring (optimized position) for direct oil lubrication
- L Annular groove with two lubrication holes and two annular grooves fitted with O-rings in the outer ring for direct oil lubrication

Bearing set – arrangement

- DB Two bearings arranged back-to-back <>
- DF Two bearings arranged face-to-face ><
- DT Two bearings arranged in tandem <<
- DG Two bearings for universal matching
- TBT Three bearings arranged back-to-back and tandem <>>
- TFT Three bearings arranged face-to-face and tandem ><<
- TT Three bearings arranged in tandem <<<
- TG Three bearings for universal matching
- QBC Four bearings arranged tandem back-to-back <<<>
- QFC Four bearings arranged tandem face-to-face >><<
- QBT Four bearings arranged back-to-back and tandem <>>>
- QFT Four bearings arranged face-to-face and tandem >><<<
- QT Four bearings arranged in tandem <<<<
- QG Four bearings for universal matching

Bearing set – preload³⁾

- A Extra light preload
- B Light preload
- C Moderate preload
- D Heavy preload
- G... Special preload, expressed in daN e.g. G240

¹⁾ Bearings in the 719 .. D (SEB) series are only available for bore diameters starting at d = 10 mm. Bearings with a bore diameter d > 280 mm were not included in the former SNFA assortment.

²⁾ Bearings in the 70 .. D (EX) series are only available for bore diameters d ≤ 240 mm.

³⁾ Equivalence between preload classes of SKF and SNFA bearings has to be evaluated in each case as it depends on the bearing size and arrangement. For additional information, contact the SKF application engineering service.

⁴⁾ PEEK and brass cages were not included in the former SNFA assortment.

Former SNFA designation system for super-precision angular contact ball bearings in the 719 .. D (SEB) and 70 .. D (EX) series

Single bearing: SEB 110 /GH 9KE1 UL	SEB	110	/GH	9	KE	1	U	L
	Series and design	Size	Variant	Tolerance class	Cage	Contact angle	Arrangement	Preload
Matched bearing set: EX 50 /S/NS 7CE3 TDTM	EX	50	/S/NS	7	CE	3	TDT	M

Bearing series and internal design

SEB In accordance with ISO dimension series 19, high-capacity SEB design
EX In accordance with ISO dimension series 10, high-capacity EX design

Bearing size

6 6 mm bore diameter¹⁾
to
360 360 mm bore diameter²⁾

Variant

– Open bearing (no designation suffix)
/S Sealed bearing
– Carbon chromium steel balls (no designation suffix)
/NS Bearing grade silicon nitride Si₃N₄ balls (hybrid bearings)
/XN Bearing with NitroMax steel rings and bearing grade silicon nitride Si₃N₄ balls (hybrid bearings)
H Two lubrication holes in the outer ring for direct oil lubrication
H1 Two lubrication holes in the outer ring (optimized position) for direct oil lubrication
GH Annular groove with two lubrication holes and two annular grooves fitted with O-rings in the outer ring for direct oil lubrication

Tolerance class

7 Dimensional and running accuracy in accordance with ABMA tolerance class ABEC 7
9 Dimensional and running accuracy in accordance with ABMA tolerance class ABEC 9

Cage

CE Fabric reinforced phenolic resin, outer ring centred
KE Glass fibre reinforced PEEK, outer ring centred
LE Machined brass, outer ring centred⁴⁾

Contact angle

1 15° contact angle
3 25° contact angle

Bearing set – arrangement

DD Two bearings arranged back-to-back <>
FF Two bearings arranged face-to-face ><
T Two bearings arranged in tandem <<
DU Two bearings for universal matching
TD Three bearings arranged back-to-back and tandem <>>
TF Three bearings arranged face-to-face and tandem >><
3T Three bearings arranged in tandem <<<
TU Three bearings for universal matching
TDT Four bearings arranged tandem back-to-back <<>>
TFT Four bearings arranged tandem face-to-face >><<
3TD Four bearings arranged back-to-back and tandem <>>>
3TF Four bearings arranged face-to-face and tandem >><<<
4T Four bearings arranged in tandem <<<<
4U Four bearings for universal matching

Bearing set – preload³⁾

L Light preload (for symmetrical sets only)
M Moderate preload (for symmetrical sets only)
F Heavy preload (for symmetrical sets only)
..daN Special preload (for asymmetrical sets TD, TF, 3TD, 3TF and for special preload executions)

Super-precision angular contact ball bearings

d 6 – 15 mm

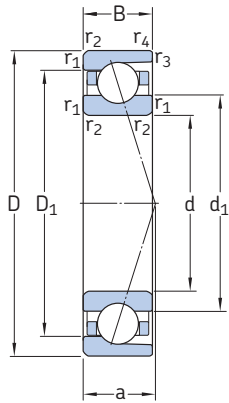

Open variant



Sealed variant
for d = 10 to 150 mm

Principal dimensions			Basic load ratings		Fatigue load limit	Calculation factor	Attainable speeds		Mass ¹⁾	Designations of open bearings ²⁾		
d	D	B	C	C ₀			P _u	f ₀		when lubricating with grease	oil-air ¹⁾	SKF
mm			kN		kN	–	r/min		kg	–		
6	17	6	2,03	0,77	0,032	8,3	120 000	180 000	0,0060	706 CD/P4A	EX 6 7CE1	
	17	6	2,03	0,77	0,032	8,3	140 000	220 000	0,0060	706 CD/HCP4A	EX 6 /NS 7CE1	
	17	6	1,95	0,75	0,032	–	110 000	160 000	0,0060	706 ACD/P4A	EX 6 7CE3	
	17	6	1,95	0,75	0,032	–	130 000	190 000	0,0060	706 ACD/HCP4A	EX 6 /NS 7CE3	
7	19	6	2,51	0,98	0,04	8,1	100 000	160 000	0,0070	707 CD/P4A	EX 7 7CE1	
	19	6	2,51	0,98	0,04	8,1	120 000	190 000	0,0070	707 CD/HCP4A	EX 7 /NS 7CE1	
	19	6	2,42	0,95	0,04	–	95 000	140 000	0,0070	707 ACD/P4A	EX 7 7CE3	
	19	6	2,42	0,95	0,04	–	110 000	170 000	0,0070	707 ACD/HCP4A	EX 7 /NS 7CE3	
8	22	7	3,25	1,37	0,057	8,4	90 000	130 000	0,011	708 CD/P4A	EX 8 7CE1	
	22	7	3,25	1,37	0,057	8,4	110 000	160 000	0,010	708 CD/HCP4A	EX 8 /NS 7CE1	
	22	7	3,19	1,34	0,056	–	80 000	120 000	0,011	708 ACD/P4A	EX 8 7CE3	
	22	7	3,19	1,34	0,056	–	95 000	150 000	0,010	708 ACD/HCP4A	EX 8 /NS 7CE3	
9	24	7	3,58	1,6	0,068	8,8	80 000	120 000	0,014	709 CD/P4A	EX 9 7CE1	
	24	7	3,58	1,6	0,068	8,8	95 000	150 000	0,012	709 CD/HCP4A	EX 9 /NS 7CE1	
	24	7	3,45	1,53	0,064	–	75 000	110 000	0,014	709 ACD/P4A	EX 9 7CE3	
	24	7	3,45	1,53	0,064	–	85 000	130 000	0,012	709 ACD/HCP4A	EX 9 /NS 7CE3	
10	22	6	2,51	1,1	0,048	9,5	70 000	110 000	0,0090	71900 CD/P4A	SEB 10 7CE1	
	22	6	2,51	1,1	0,048	9,5	80 000	120 000	0,0080	71900 CD/HCP4A	SEB 10 /NS 7CE1	
	22	6	2,42	1,06	0,045	–	63 000	95 000	0,0090	71900 ACD/P4A	SEB 10 7CE3	
	22	6	2,42	1,06	0,045	–	70 000	110 000	0,0080	71900 ACD/HCP4A	SEB 10 /NS 7CE3	
	26	8	4,1	1,66	0,071	8,3	75 000	110 000	0,018	7000 CD/P4A	EX 10 7CE1	
	26	8	4,1	1,66	0,071	8,3	90 000	140 000	0,016	7000 CD/HCP4A	EX 10 /NS 7CE1	
	26	8	3,97	1,6	0,067	–	67 000	100 000	0,018	7000 ACD/P4A	EX 10 7CE3	
	26	8	3,97	1,6	0,067	–	80 000	120 000	0,016	7000 ACD/HCP4A	EX 10 /NS 7CE3	
12	24	6	2,65	1,25	0,053	9,8	63 000	95 000	0,010	71901 CD/P4A	SEB 12 7CE1	
	24	6	2,65	1,25	0,053	9,8	75 000	110 000	0,0090	71901 CD/HCP4A	SEB 12 /NS 7CE1	
	24	6	2,55	1,18	0,05	–	56 000	85 000	0,010	71901 ACD/P4A	SEB 12 7CE3	
	24	6	2,55	1,18	0,05	–	67 000	100 000	0,0090	71901 ACD/HCP4A	SEB 12 /NS 7CE3	
	28	8	4,49	1,9	0,08	8,7	67 000	100 000	0,020	7001 CD/P4A	EX 12 7CE1	
	28	8	4,49	1,9	0,08	8,7	80 000	120 000	0,017	7001 CD/HCP4A	EX 12 /NS 7CE1	
	28	8	4,36	1,83	0,078	–	60 000	90 000	0,020	7001 ACD/P4A	EX 12 7CE3	
	28	8	4,36	1,83	0,078	–	70 000	110 000	0,017	7001 ACD/HCP4A	EX 12 /NS 7CE3	
	15	28	7	3,97	1,9	0,08	9,6	56 000	85 000	0,015	71902 CD/P4A	SEB 15 7CE1
		28	7	3,97	1,9	0,08	9,6	70 000	100 000	0,013	71902 CD/HCP4A	SEB 15 /NS 7CE1
28		7	3,77	1,8	0,078	–	50 000	75 000	0,015	71902 ACD/P4A	SEB 15 7CE3	
28		7	3,77	1,8	0,078	–	60 000	90 000	0,013	71902 ACD/HCP4A	SEB 15 /NS 7CE3	
32		9	5,2	2,45	0,104	9,3	56 000	85 000	0,028	7002 CD/P4A	EX 15 7CE1	
32		9	5,2	2,45	0,104	9,3	67 000	100 000	0,025	7002 CD/HCP4A	EX 15 /NS 7CE1	
32		9	4,94	2,32	0,098	–	50 000	75 000	0,028	7002 ACD/P4A	EX 15 7CE3	
32		9	4,94	2,32	0,098	–	60 000	95 000	0,025	7002 ACD/HCP4A	EX 15 /NS 7CE3	

¹⁾ Applicable to open bearings only

²⁾ For designations of sealed bearings and other variants, refer to table 16 on pages 34 and 35.

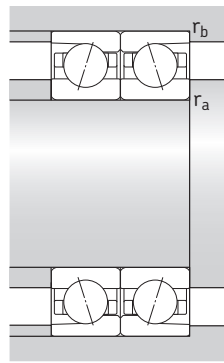
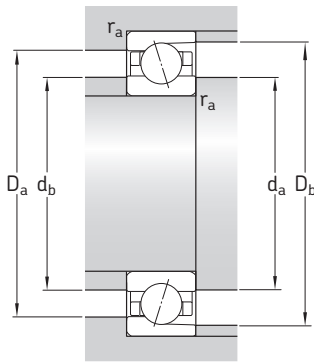

Dimensions

Abutment and fillet dimensions

d	d ₁ ~	D ₁ ~	r _{1,2} min	r _{3,4} min	a	d _{a,d_b} min	D _a max	D _b max	r _a max	r _b max
mm						mm				
6	9,5	13,5	0,3	0,15	5	8,5	15	16,2	0,3	0,15
	9,5	13,5	0,3	0,15	5	8,5	15	16,2	0,3	0,15
	9,5	13,5	0,3	0,15	5	8,5	15	16,2	0,3	0,15
	9,5	13,5	0,3	0,15	5	8,5	15	16,2	0,3	0,15
7	10,8	15,2	0,3	0,15	5	9,5	17	18,2	0,3	0,15
	10,8	15,2	0,3	0,15	5	9,5	17	18,2	0,3	0,15
	10,8	15,2	0,3	0,15	5	9,5	17	18,2	0,3	0,15
	10,8	15,2	0,3	0,15	5	9,5	17	18,2	0,3	0,15
8	12,6	17,4	0,3	0,2	6	10	20	20,6	0,3	0,2
	12,6	17,4	0,3	0,2	6	10	20	20,6	0,3	0,2
	12,6	17,4	0,3	0,2	7	10	20	20,6	0,3	0,2
	12,6	17,4	0,3	0,2	7	10	20	20,6	0,3	0,2
9	14,1	18,9	0,3	0,2	6	11	22	22,6	0,3	0,2
	14,1	18,9	0,3	0,2	6	11	22	22,6	0,3	0,2
	14,1	18,9	0,3	0,2	7	11	22	22,6	0,3	0,2
	14,1	18,9	0,3	0,2	7	11	22	22,6	0,3	0,2
10	14	18	0,3	0,2	5	12	20	20,6	0,3	0,2
	14	18	0,3	0,2	5	12	20	20,6	0,3	0,2
	14	18	0,3	0,2	7	12	20	20,6	0,3	0,2
	14	18	0,3	0,2	7	12	20	20,6	0,3	0,2
	15,1	20,9	0,3	0,2	6	12	24	24,6	0,3	0,2
	15,1	20,9	0,3	0,2	6	12	24	24,6	0,3	0,2
	15,1	20,9	0,3	0,2	8	12	24	24,6	0,3	0,2
	15,1	20,9	0,3	0,2	8	12	24	24,6	0,3	0,2
12	16	20	0,3	0,2	5	14	22	22,6	0,3	0,2
	16	20	0,3	0,2	5	14	22	22,6	0,3	0,2
	16	20	0,3	0,2	7	14	22	22,6	0,3	0,2
	16	20	0,3	0,2	7	14	22	22,6	0,3	0,2
	17,1	22,9	0,3	0,2	7	14	26	26,6	0,3	0,2
	17,1	22,9	0,3	0,2	7	14	26	26,6	0,3	0,2
	17,1	22,9	0,3	0,2	9	14	26	26,6	0,3	0,2
	17,1	22,9	0,3	0,2	9	14	26	26,6	0,3	0,2
	17,1	22,9	0,3	0,2	9	14	26	26,6	0,3	0,2
15	19,1	23,9	0,3	0,2	6	17	26	26,6	0,3	0,2
	19,1	23,9	0,3	0,2	6	17	26	26,6	0,3	0,2
	19,1	23,9	0,3	0,2	9	17	26	26,6	0,3	0,2
	19,1	23,9	0,3	0,2	9	17	26	26,6	0,3	0,2
	20,6	26,4	0,3	0,2	8	17	30	30,6	0,3	0,2
	20,6	26,4	0,3	0,2	8	17	30	30,6	0,3	0,2
	20,6	26,4	0,3	0,2	10	17	30	30,6	0,3	0,2
	20,6	26,4	0,3	0,2	10	17	30	30,6	0,3	0,2

Super-precision angular contact ball bearings

d 17 – 35 mm

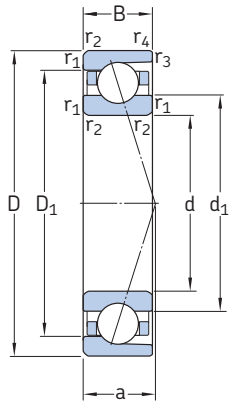

Open variant



Sealed variant
for d = 10 to 150 mm

Principal dimensions			Basic load ratings		Fatigue load limit	Calculation factor	Attainable speeds		Mass ¹⁾	Designations of open bearings ²⁾	SNFA
d	D	B	C	C ₀	P _u	f ₀	when lubricating with grease	oil-air ¹⁾	kg	SKF	
mm			kN		kN	–	r/min		kg	–	
17	30	7	4,16	2,08	0,088	9,8	50 000	75 000	0,017	71903 CD/P4A	SEB 17 7CE1
	30	7	4,16	2,08	0,088	9,8	63 000	90 000	0,017	71903 CD/HCP4A	SEB 17 /NS 7CE1
	30	7	3,97	2	0,085	–	45 000	67 000	0,017	71903 ACD/P4A	SEB 17 7CE3
	30	7	3,97	2	0,085	–	53 000	80 000	0,017	71903 ACD/HCP4A	SEB 17 /NS 7CE3
	35	10	6,76	3,25	0,137	9,1	50 000	75 000	0,037	7003 CD/P4A	EX 17 7CE1
	35	10	6,76	3,25	0,137	9,1	60 000	95 000	0,032	7003 CD/HCP4A	EX 17 /NS 7CE1
	35	10	6,5	3,1	0,132	–	45 000	70 000	0,037	7003 ACD/P4A	EX 17 7CE3
	35	10	6,5	3,1	0,132	–	56 000	85 000	0,032	7003 ACD/HCP4A	EX 17 /NS 7CE3
20	37	9	6,05	3,2	0,137	9,8	43 000	63 000	0,035	71904 CD/P4A	SEB 20 7CE1
	37	9	6,05	3,2	0,137	9,8	53 000	75 000	0,031	71904 CD/HCP4A	SEB 20 /NS 7CE1
	37	9	5,72	3,05	0,129	–	38 000	56 000	0,035	71904 ACD/P4A	SEB 20 7CE3
	37	9	5,72	3,05	0,129	–	45 000	67 000	0,031	71904 ACD/HCP4A	SEB 20 /NS 7CE3
	42	12	8,71	4,3	0,18	9,2	43 000	63 000	0,065	7004 CD/P4A	EX 20 7CE1
	42	12	8,71	4,3	0,18	9,2	50 000	80 000	0,058	7004 CD/HCP4A	EX 20 /NS 7CE1
	42	12	8,32	4,15	0,173	–	38 000	60 000	0,065	7004 ACD/P4A	EX 20 7CE3
	42	12	8,32	4,15	0,173	–	45 000	70 000	0,058	7004 ACD/HCP4A	EX 20 /NS 7CE3
25	42	9	6,76	4	0,17	10,2	36 000	53 000	0,042	71905 CD/P4A	SEB 25 7CE1
	42	9	6,76	4	0,17	10,2	45 000	63 000	0,037	71905 CD/HCP4A	SEB 25 /NS 7CE1
	42	9	6,37	3,8	0,16	–	32 000	48 000	0,042	71905 ACD/P4A	SEB 25 7CE3
	42	9	6,37	3,8	0,16	–	38 000	56 000	0,037	71905 ACD/HCP4A	SEB 25 /NS 7CE3
	47	12	9,56	5,2	0,22	9,6	36 000	56 000	0,075	7005 CD/P4A	EX 25 7CE1
	47	12	9,56	5,2	0,22	9,6	43 000	67 000	0,066	7005 CD/HCP4A	EX 25 /NS 7CE1
	47	12	9,23	5	0,212	–	34 000	50 000	0,075	7005 ACD/P4A	EX 25 7CE3
	47	12	9,23	5	0,212	–	40 000	60 000	0,066	7005 ACD/HCP4A	EX 25 /NS 7CE3
30	47	9	7,15	4,55	0,193	10,4	30 000	45 000	0,048	71906 CD/P4A	SEB 30 7CE1
	47	9	7,15	4,55	0,193	10,4	38 000	53 000	0,043	71906 CD/HCP4A	SEB 30 /NS 7CE1
	47	9	6,76	4,3	0,183	–	26 000	40 000	0,048	71906 ACD/P4A	SEB 30 7CE3
	47	9	6,76	4,3	0,183	–	32 000	48 000	0,043	71906 ACD/HCP4A	SEB 30 /NS 7CE3
	55	13	14,3	8	0,34	9,4	32 000	48 000	0,11	7006 CD/P4A	EX 30 7CE1
	55	13	14,3	8	0,34	9,4	38 000	56 000	0,094	7006 CD/HCP4A	EX 30 /NS 7CE1
	55	13	13,8	7,65	0,325	–	28 000	43 000	0,11	7006 ACD/P4A	EX 30 7CE3
	55	13	13,8	7,65	0,325	–	34 000	53 000	0,094	7006 ACD/HCP4A	EX 30 /NS 7CE3
35	55	10	9,75	6,55	0,275	10,4	26 000	40 000	0,074	71907 CD/P4A	SEB 35 7CE1
	55	10	9,75	6,55	0,275	10,4	32 000	45 000	0,065	71907 CD/HCP4A	SEB 35 /NS 7CE1
	55	10	9,23	6,2	0,26	–	22 000	36 000	0,074	71907 ACD/P4A	SEB 35 7CE3
	55	10	9,23	6,2	0,26	–	28 000	43 000	0,065	71907 ACD/HCP4A	SEB 35 /NS 7CE3
	62	14	15,6	9,5	0,4	9,7	24 000	36 000	0,15	7007 CD/P4A	EX 35 7CE1
	62	14	15,6	9,5	0,4	9,7	28 000	43 000	0,13	7007 CD/HCP4A	EX 35 /NS 7CE1
	62	14	14,8	9	0,38	–	20 000	32 000	0,15	7007 ACD/P4A	EX 35 7CE3
	62	14	14,8	9	0,38	–	24 000	38 000	0,13	7007 ACD/HCP4A	EX 35 /NS 7CE3

¹⁾ Applicable to open bearings only

²⁾ For designations of sealed bearings and other variants, refer to table 16 on pages 34 and 35.

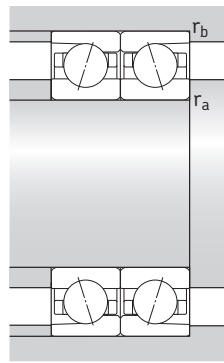
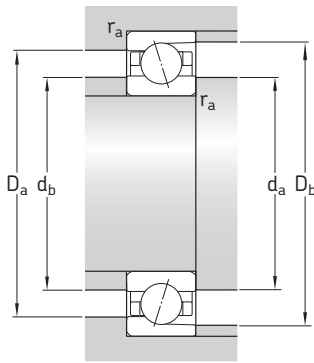

Dimensions

Abutment and fillet dimensions

d	d ₁ ~	D ₁ ~	r _{1,2} min	r _{3,4} min	a	d _{a,d_b} min	D _a max	D _b max	r _a max	r _b max
mm						mm				
17	20,9	25,9	0,3	0,2	7	19	28	28,6	0,3	0,2
	20,9	25,9	0,3	0,2	7	19	28	28,6	0,3	0,2
	20,9	25,9	0,3	0,2	9	19	28	28,6	0,3	0,2
	20,9	25,9	0,3	0,2	9	19	28	28,6	0,3	0,2
	22,6	29,3	0,3	0,2	9	19	33	33,6	0,3	0,2
	22,6	29,3	0,3	0,2	9	19	33	33,6	0,3	0,2
	22,6	29,3	0,3	0,2	11	19	33	33,6	0,3	0,2
	22,6	29,3	0,3	0,2	11	19	33	33,6	0,3	0,2
20	25,6	31,4	0,3	0,2	8	22	35	35,6	0,3	0,2
	25,6	31,4	0,3	0,2	8	22	35	35,6	0,3	0,2
	25,6	31,4	0,3	0,2	11	22	35	35,6	0,3	0,2
	25,6	31,4	0,3	0,2	11	22	35	35,6	0,3	0,2
	27,1	34,8	0,6	0,3	10	23,2	38,8	40	0,6	0,3
	27,1	34,8	0,6	0,3	10	23,2	38,8	40	0,6	0,3
	27,1	34,8	0,6	0,3	13	23,2	38,8	40	0,6	0,3
	27,1	34,8	0,6	0,3	13	23,2	38,8	40	0,6	0,3
25	30,6	36,4	0,3	0,2	9	27	40	40,6	0,3	0,2
	30,6	36,4	0,3	0,2	9	27	40	40,6	0,3	0,2
	30,6	36,4	0,3	0,2	12	27	40	40,6	0,3	0,2
	30,6	36,4	0,3	0,2	12	27	40	40,6	0,3	0,2
	32,1	39,9	0,6	0,3	11	28,2	43,8	45	0,6	0,3
	32,1	39,9	0,6	0,3	11	28,2	43,8	45	0,6	0,3
	32,1	39,9	0,6	0,3	15	28,2	43,8	45	0,6	0,3
	32,1	39,9	0,6	0,3	15	28,2	43,8	45	0,6	0,3
30	35,6	41,4	0,3	0,2	10	32	45	45,6	0,3	0,2
	35,6	41,4	0,3	0,2	10	32	45	45,6	0,3	0,2
	35,6	41,4	0,3	0,2	14	32	45	45,6	0,3	0,2
	35,6	41,4	0,3	0,2	14	32	45	45,6	0,3	0,2
	37,7	47,3	1	0,3	12	34,6	50,4	53	1	0,3
	37,7	47,3	1	0,3	12	34,6	50,4	53	1	0,3
	37,7	47,3	1	0,3	17	34,6	50,4	53	1	0,3
	37,7	47,3	1	0,3	17	34,6	50,4	53	1	0,3
35	41,6	48,4	0,6	0,3	11	38,2	51,8	53,6	0,6	0,3
	41,6	48,4	0,6	0,3	11	38,2	51,8	53,6	0,6	0,3
	41,6	48,4	0,6	0,3	16	38,2	51,8	53,6	0,6	0,3
	41,6	48,4	0,6	0,3	16	38,2	51,8	53,6	0,6	0,3
	43,7	53,3	1	0,3	14	39,6	57,4	60	1	0,3
	43,7	53,3	1	0,3	14	39,6	57,4	60	1	0,3
	43,7	53,3	1	0,3	19	39,6	57,4	60	1	0,3
	43,7	53,3	1	0,3	19	39,6	57,4	60	1	0,3

Super-precision angular contact ball bearings

d 40 – 60 mm

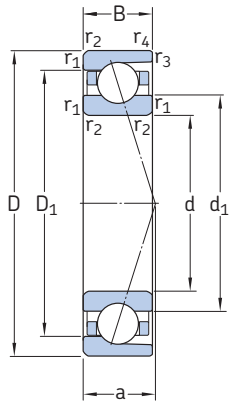

Open variant

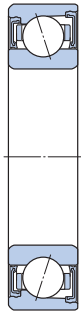

Sealed variant
for d = 10 to 150 mm

Principal dimensions			Basic load ratings		Fatigue load limit	Calculation factor	Attainable speeds		Mass ¹⁾	Designations of open bearings ²⁾	SNFA
d	D	B	C	C ₀	P _u	f ₀	when lubricating with grease	oil-air ¹⁾		SKF	
mm				kN	kN	–	r/min		kg	–	
40	62	12	12,4	8,5	0,36	10,4	20 000	34 000	0,11	71908 CD/P4A	SEB 40 7CE1
	62	12	12,4	8,5	0,36	10,4	28 000	40 000	0,096	71908 CD/HCP4A	SEB 40 /NS 7CE1
	62	12	11,7	8	0,34	–	18 000	30 000	0,11	71908 ACD/P4A	SEB 40 7CE3
	62	12	11,7	8	0,34	–	22 000	36 000	0,096	71908 ACD/HCP4A	SEB 40 /NS 7CE3
	68	15	16,8	11	0,465	10,0	20 000	32 000	0,19	7008 CD/P4A ³⁾	EX 40 7CE1 ³⁾
	68	15	16,8	11	0,465	10,0	24 000	38 000	0,16	7008 CD/HCP4A ³⁾	EX 40 /NS 7CE1 ³⁾
	68	15	15,9	10,4	0,44	–	19 000	30 000	0,19	7008 ACD/P4A ³⁾	EX 40 7CE3 ³⁾
	68	15	15,9	10,4	0,44	–	22 000	34 000	0,16	7008 ACD/HCP4A ³⁾	EX 40 /NS 7CE3 ³⁾
45	68	12	13	9,5	0,4	10,5	19 000	32 000	0,13	71909 CD/P4A	SEB 45 7CE1
	68	12	13	9,5	0,4	10,5	24 000	36 000	0,11	71909 CD/HCP4A	SEB 45 /NS 7CE1
	68	12	12,4	9	0,38	–	17 000	28 000	0,13	71909 ACD/P4A	SEB 45 7CE3
	68	12	12,4	9	0,38	–	20 000	34 000	0,11	71909 ACD/HCP4A	SEB 45 /NS 7CE3
	75	16	28,6	22,4	0,95	15,1	19 000	30 000	0,23	7009 CD/P4A ³⁾	EX 45 7CE1 ³⁾
	75	16	28,6	22,4	0,95	15,1	22 000	34 000	0,20	7009 CD/HCP4A ³⁾	EX 45 /NS 7CE1 ³⁾
	75	16	27,6	21,6	0,9	–	17 000	26 000	0,23	7009 ACD/P4A ³⁾	EX 45 7CE3 ³⁾
	75	16	27,6	21,6	0,9	–	20 000	32 000	0,20	7009 ACD/HCP4A ³⁾	EX 45 /NS 7CE3 ³⁾
50	72	12	13,5	10,4	0,44	10,7	17 000	28 000	0,13	71910 CD/P4A	SEB 50 7CE1
	72	12	13,5	10,4	0,44	10,7	22 000	34 000	0,11	71910 CD/HCP4A	SEB 50 /NS 7CE1
	72	12	12,7	9,8	0,415	–	16 000	26 000	0,13	71910 ACD/P4A	SEB 50 7CE3
	72	12	12,7	9,8	0,415	–	19 000	30 000	0,11	71910 ACD/HCP4A	SEB 50 /NS 7CE3
	80	16	29,6	24	1,02	15,4	17 000	28 000	0,25	7010 CD/P4A ³⁾	EX 50 7CE1 ³⁾
	80	16	29,6	24	1,02	15,4	20 000	32 000	0,21	7010 CD/HCP4A ³⁾	EX 50 /NS 7CE1 ³⁾
	80	16	28,1	23,2	0,98	–	15 000	24 000	0,25	7010 ACD/P4A ³⁾	EX 50 7CE3 ³⁾
	80	16	28,1	23,2	0,98	–	18 000	28 000	0,21	7010 ACD/HCP4A ³⁾	EX 50 /NS 7CE3 ³⁾
55	80	13	19,5	14,6	0,62	10,4	16 000	26 000	0,18	71911 CD/P4A	SEB 55 7CE1
	80	13	19,5	14,6	0,62	10,4	19 000	30 000	0,15	71911 CD/HCP4A	SEB 55 /NS 7CE1
	80	13	18,2	13,7	0,585	–	15 000	24 000	0,18	71911 ACD/P4A	SEB 55 7CE3
	80	13	18,2	13,7	0,585	–	17 000	28 000	0,15	71911 ACD/HCP4A	SEB 55 /NS 7CE3
	90	18	39,7	32,5	1,37	15,1	15 000	24 000	0,37	7011 CD/P4A ³⁾	EX 55 7CE1 ³⁾
	90	18	39,7	32,5	1,37	15,1	18 000	28 000	0,31	7011 CD/HCP4A ³⁾	EX 55 /NS 7CE1 ³⁾
	90	18	37,1	31	1,32	–	14 000	22 000	0,37	7011 ACD/P4A ³⁾	EX 55 7CE3 ³⁾
	90	18	37,1	31	1,32	–	17 000	26 000	0,31	7011 ACD/HCP4A ³⁾	EX 55 /NS 7CE3 ³⁾
60	85	13	19,9	15,3	0,655	10,5	15 000	24 000	0,19	71912 CD/P4A	SEB 60 7CE1
	85	13	19,9	15,3	0,655	10,5	18 000	28 000	0,16	71912 CD/HCP4A	SEB 60 /NS 7CE1
	85	13	18,6	14,6	0,62	–	14 000	22 000	0,19	71912 ACD/P4A	SEB 60 7CE3
	85	13	18,6	14,6	0,62	–	16 000	26 000	0,16	71912 ACD/HCP4A	SEB 60 /NS 7CE3
	95	18	40,3	34,5	1,5	15,4	14 000	22 000	0,40	7012 CD/P4A ³⁾	EX 60 7CE1 ³⁾
	95	18	40,3	34,5	1,5	15,4	17 000	26 000	0,34	7012 CD/HCP4A ³⁾	EX 60 /NS 7CE1 ³⁾
	95	18	39	33,5	1,4	–	13 000	20 000	0,40	7012 ACD/P4A ³⁾	EX 60 7CE3 ³⁾
	95	18	39	33,5	1,4	–	15 000	24 000	0,34	7012 ACD/HCP4A ³⁾	EX 60 /NS 7CE3 ³⁾

¹⁾ Applicable to open bearings only

²⁾ For designations of sealed bearings and other variants, refer to table 16 on pages 34 and 35.

³⁾ Bearing is available with a PEEK cage, designation suffix TNHA (KE), on request.

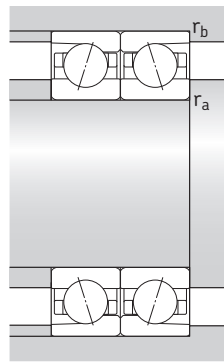
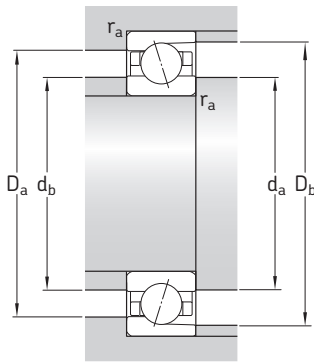

Dimensions

Abutment and fillet dimensions

d	d ₁ ~	D ₁ ~	r _{1,2} min	r _{3,4} min	a	d _{a,d_b} min	D _a max	D _b max	r _a max	r _b max
mm						mm				
40	47,1	54,9	0,6	0,3	13	43,2	58,8	60,6	0,6	0,3
	47,1	54,9	0,6	0,3	13	43,2	58,8	60,6	0,6	0,3
	47,1	54,9	0,6	0,3	18	43,2	58,8	60,6	0,6	0,3
	47,1	54,9	0,6	0,3	18	43,2	58,8	60,6	0,6	0,3
	49,2	58,8	1	0,3	15	44,6	63,4	66	1	0,3
	49,2	58,8	1	0,3	15	44,6	63,4	66	1	0,3
	49,2	58,8	1	0,3	20	44,6	63,4	66	1	0,3
	49,2	58,8	1	0,3	20	44,6	63,4	66	1	0,3
45	52,6	60,4	0,6	0,3	14	48,2	64,8	66,6	0,6	0,3
	52,6	60,4	0,6	0,3	14	48,2	64,8	66,6	0,6	0,3
	52,6	60,4	0,6	0,3	19	48,2	64,8	66,6	0,6	0,3
	52,6	60,4	0,6	0,3	19	48,2	64,8	66,6	0,6	0,3
	54,2	65,8	1	0,3	16	49,6	70,4	73	1	0,3
	54,2	65,8	1	0,3	16	49,6	70,4	73	1	0,3
	54,2	65,8	1	0,3	22	49,6	70,4	73	1	0,3
	54,2	65,8	1	0,3	22	49,6	70,4	73	1	0,3
50	57,1	64,9	0,6	0,3	14	53,2	68,8	70,6	0,6	0,3
	57,1	64,9	0,6	0,3	14	53,2	68,8	70,6	0,6	0,3
	57,1	64,9	0,6	0,3	20	53,2	68,8	70,6	0,6	0,3
	57,1	64,9	0,6	0,3	20	53,2	68,8	70,6	0,6	0,3
	59,2	70,8	1	0,3	17	54,6	75,4	78	1	0,3
	59,2	70,8	1	0,3	17	54,6	75,4	78	1	0,3
	59,2	70,8	1	0,3	23	54,6	75,4	78	1	0,3
	59,2	70,8	1	0,3	23	54,6	75,4	78	1	0,3
55	62,7	72,3	1	0,3	16	59,6	75,4	78	1	0,3
	62,7	72,3	1	0,3	16	59,6	75,4	78	1	0,3
	62,7	72,3	1	0,3	22	59,6	75,4	78	1	0,3
	62,7	72,3	1	0,3	22	59,6	75,4	78	1	0,3
	65,8	79,2	1,1	0,6	19	61	84	86,8	1	0,6
	65,8	79,2	1,1	0,6	19	61	84	86,8	1	0,6
	65,8	79,2	1,1	0,6	26	61	84	86,8	1	0,6
	65,8	79,2	1,1	0,6	26	61	84	86,8	1	0,6
60	67,7	77,3	1	0,3	16	64,6	80,4	83	1	0,3
	67,7	77,3	1	0,3	16	64,6	80,4	83	1	0,3
	67,7	77,3	1	0,3	24	64,6	80,4	83	1	0,3
	67,7	77,3	1	0,3	24	64,6	80,4	83	1	0,3
	70,8	84,2	1,1	0,6	20	66	89	91,8	1	0,6
	70,8	84,2	1,1	0,6	20	66	89	91,8	1	0,6
	70,8	84,2	1,1	0,6	27	66	89	91,8	1	0,6
	70,8	84,2	1,1	0,6	27	66	89	91,8	1	0,6

Super-precision angular contact ball bearings

d 65 – 85 mm

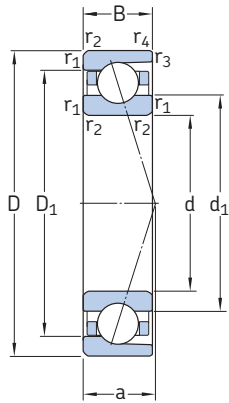

Open variant

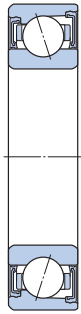

Sealed variant
for d = 10 to 150 mm

Principal dimensions			Basic load ratings		Fatigue load limit	Calculation factor	Attainable speeds		Mass ¹⁾	Designations of open bearings ²⁾	SNFA
d	D	B	C	C ₀	P _u	f ₀	when lubricating with grease	oil-air ¹⁾		SKF	
mm			kN	kN	–	r/min		kg	–		
65	90	13	20,8	17	0,71	10,7	14 000	22 000	0,21	71913 CD/P4A	SEB 65 7CE1
	90	13	20,8	17	0,71	10,7	17 000	26 000	0,17	71913 CD/HCP4A	SEB 65 /NS 7CE1
	90	13	19,5	16	0,68	–	13 000	20 000	0,21	71913 ACD/P4A	SEB 65 7CE3
	90	13	19,5	16	0,68	–	15 000	24 000	0,17	71913 ACD/HCP4A	SEB 65 /NS 7CE3
	100	18	41,6	37,5	1,6	15,6	14 000	22 000	0,42	7013 CD/P4A	EX 65 7CE1
	100	18	41,6	37,5	1,6	15,6	16 000	24 000	0,36	7013 CD/HCP4A	EX 65 /NS 7CE1
	100	18	39	35,5	1,5	–	12 000	19 000	0,42	7013 ACD/P4A	EX 65 7CE3
	100	18	39	35,5	1,5	–	15 000	22 000	0,36	7013 ACD/HCP4A	EX 65 /NS 7CE3
70	100	16	34,5	34	1,43	16,2	13 000	20 000	0,33	71914 CD/P4A	SEB 70 7CE1
	100	16	34,5	34	1,43	16,2	16 000	24 000	0,28	71914 CD/HCP4A	SEB 70 /NS 7CE1
	100	16	32,5	32,5	1,37	–	11 000	18 000	0,33	71914 ACD/P4A	SEB 70 7CE3
	100	16	32,5	32,5	1,37	–	14 000	22 000	0,28	71914 ACD/HCP4A	SEB 70 /NS 7CE3
	110	20	52	45,5	1,93	15,5	12 000	19 000	0,59	7014 CD/P4A ³⁾	EX 70 7CE1 ³⁾
	110	20	52	45,5	1,93	15,5	15 000	22 000	0,49	7014 CD/HCP4A ³⁾	EX 70 /NS 7CE1 ³⁾
	110	20	48,8	44	1,86	–	11 000	17 000	0,59	7014 ACD/P4A ³⁾	EX 70 7CE3 ³⁾
	110	20	48,8	44	1,86	–	13 000	20 000	0,49	7014 ACD/HCP4A ³⁾	EX 70 /NS 7CE3 ³⁾
75	105	16	35,8	37,5	1,56	16,3	12 000	19 000	0,35	71915 CD/P4A	SEB 75 7CE1
	105	16	35,8	37,5	1,56	16,3	15 000	22 000	0,30	71915 CD/HCP4A	SEB 75 /NS 7CE1
	105	16	33,8	35,5	1,5	–	10 000	17 000	0,35	71915 ACD/P4A	SEB 75 7CE3
	105	16	33,8	35,5	1,5	–	13 000	20 000	0,30	71915 ACD/HCP4A	SEB 75 /NS 7CE3
	115	20	52,7	49	2,08	15,7	11 000	18 000	0,62	7015 CD/P4A	EX 75 7CE1
	115	20	52,7	49	2,08	15,7	14 000	22 000	0,52	7015 CD/HCP4A	EX 75 /NS 7CE1
	115	20	49,4	46,5	1,96	–	10 000	16 000	0,62	7015 ACD/P4A	EX 75 7CE3
	115	20	49,4	46,5	1,96	–	13 000	20 000	0,52	7015 ACD/HCP4A	EX 75 /NS 7CE3
80	110	16	36,4	39	1,66	16,5	11 000	18 000	0,37	71916 CD/P4A	SEB 80 7CE1
	110	16	36,4	39	1,66	16,5	15 000	22 000	0,31	71916 CD/HCP4A	SEB 80 /NS 7CE1
	110	16	34,5	36,5	1,56	–	9 500	16 000	0,37	71916 ACD/P4A	SEB 80 7CE3
	110	16	34,5	36,5	1,56	–	12 000	19 000	0,31	71916 ACD/HCP4A	SEB 80 /NS 7CE3
	125	22	65	61	2,55	15,5	10 000	17 000	0,85	7016 CD/P4A ³⁾	EX 80 7CE1 ³⁾
	125	22	65	61	2,55	15,5	13 000	20 000	0,71	7016 CD/HCP4A ³⁾	EX 80 /NS 7CE1 ³⁾
	125	22	62,4	58,5	2,45	–	9 500	15 000	0,85	7016 ACD/P4A ³⁾	EX 80 7CE3 ³⁾
	125	22	62,4	58,5	2,45	–	12 000	18 000	0,71	7016 ACD/HCP4A ³⁾	EX 80 /NS 7CE3 ³⁾
85	120	18	46,2	48	2,04	16,2	10 000	17 000	0,53	71917 CD/P4A	SEB 85 7CE1
	120	18	46,2	48	2,04	16,2	14 000	20 000	0,44	71917 CD/HCP4A	SEB 85 /NS 7CE1
	120	18	43,6	45,5	1,93	–	9 000	15 000	0,53	71917 ACD/P4A	SEB 85 7CE3
	120	18	43,6	45,5	1,93	–	11 000	18 000	0,44	71917 ACD/HCP4A	SEB 85 /NS 7CE3
	130	22	67,6	65,5	2,65	15,7	10 000	16 000	0,89	7017 CD/P4A ³⁾	EX 85 7CE1 ³⁾
	130	22	67,6	65,5	2,65	15,7	12 000	19 000	0,74	7017 CD/HCP4A ³⁾	EX 85 /NS 7CE1 ³⁾
	130	22	63,7	62	2,5	–	9 000	14 000	0,89	7017 ACD/P4A ³⁾	EX 85 7CE3 ³⁾
	130	22	63,7	62	2,5	–	11 000	17 000	0,74	7017 ACD/HCP4A ³⁾	EX 85 /NS 7CE3 ³⁾

¹⁾ Applicable to open bearings only

²⁾ For designations of sealed bearings and other variants, refer to table 16 on pages 34 and 35.

³⁾ Bearing is available with a PEEK cage, designation suffix TNHA (KE), on request.

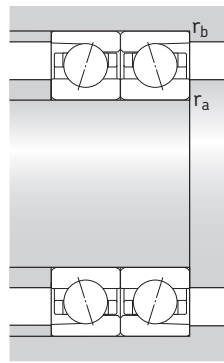
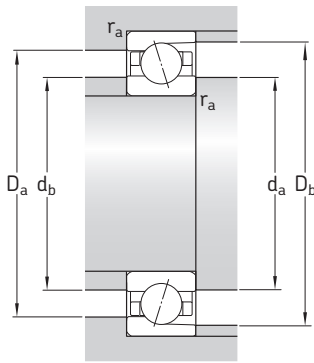

Dimensions

Abutment and fillet dimensions

d	d ₁ ~	D ₁ ~	r _{1,2} min	r _{3,4} min	a	d _{a,d_b} min	D _a max	D _b max	r _a max	r _b max
mm						mm				
65	72,7	82,3	1	0,3	17	69,6	85,4	88	1	0,3
	72,7	82,3	1	0,3	17	69,6	85,4	88	1	0,3
	72,7	82,3	1	0,3	25	69,6	85,4	88	1	0,3
	72,7	82,3	1	0,3	25	69,6	85,4	88	1	0,3
	75,8	89,2	1,1	0,6	20	71	94	96,8	1	0,6
	75,8	89,2	1,1	0,6	20	71	94	96,8	1	0,6
	75,8	89,2	1,1	0,6	28	71	94	96,8	1	0,6
	75,8	89,2	1,1	0,6	28	71	94	96,8	1	0,6
70	79,2	90,8	1	0,3	19	74,6	95,4	98	1	0,3
	79,2	90,8	1	0,3	19	74,6	95,4	98	1	0,3
	79,2	90,8	1	0,3	28	74,6	95,4	98	1	0,3
	79,2	90,8	1	0,3	28	74,6	95,4	98	1	0,3
	82,3	97,7	1,1	0,6	22	76	104	106	1	0,6
	82,3	97,7	1,1	0,6	22	76	104	106	1	0,6
	82,3	97,7	1,1	0,6	31	76	104	106	1	0,6
	82,3	97,7	1,1	0,6	31	76	104	106	1	0,6
75	84,2	95,8	1	0,3	20	79,6	100	103	1	0,3
	84,2	95,8	1	0,3	20	79,6	100	103	1	0,3
	84,2	95,8	1	0,3	29	79,6	100	103	1	0,3
	84,2	95,8	1	0,3	29	79,6	100	103	1	0,3
	87,3	102,7	1,1	0,6	23	81	109	111	1	0,6
	87,3	102,7	1,1	0,6	23	81	109	111	1	0,6
	87,3	102,7	1,1	0,6	32	81	109	111	1	0,6
	87,3	102,7	1,1	0,6	32	81	109	111	1	0,6
80	89,2	100,8	1	0,3	21	84,6	105	108	1	0,3
	89,2	100,8	1	0,3	21	84,6	105	108	1	0,3
	89,2	100,8	1	0,3	30	84,6	105	108	1	0,3
	89,2	100,8	1	0,3	30	84,6	105	108	1	0,3
	93,9	111,1	1,1	0,6	25	86	119	121	1	0,6
	93,9	111,1	1,1	0,6	25	86	119	121	1	0,6
	93,9	111,1	1,1	0,6	35	86	119	121	1	0,6
	93,9	111,1	1,1	0,6	35	86	119	121	1	0,6
85	95,8	109,2	1,1	0,6	23	91	114	116	1	0,6
	95,8	109,2	1,1	0,6	23	91	114	116	1	0,6
	95,8	109,2	1,1	0,6	33	91	114	116	1	0,6
	95,8	109,2	1,1	0,6	33	91	114	116	1	0,6
	98,9	116,1	1,1	0,6	26	91	124	126	1	0,6
	98,9	116,1	1,1	0,6	26	91	124	126	1	0,6
	98,9	116,1	1,1	0,6	36	91	124	126	1	0,6
	98,9	116,1	1,1	0,6	36	91	124	126	1	0,6

Super-precision angular contact ball bearings

d 90 – 110 mm

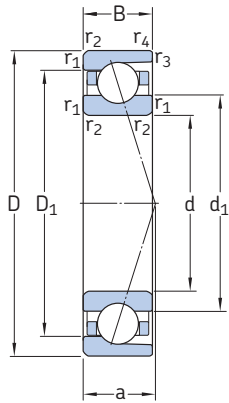

Open variant



Sealed variant
for d = 10 to 150 mm

Principal dimensions			Basic load ratings		Fatigue load limit	Calculation factor	Attainable speeds		Mass ¹⁾	Designations of open bearings ²⁾	
d	D	B	C	C ₀			P _u	f ₀		when lubricating with grease	oil-air ¹⁾
mm			kN		kN	–	r/min		kg	–	
90	125	18	47,5	51	2,08	16,3	9 500	16 000	0,55	71918 CD/P4A ³⁾	SEB 90 7CE1 ³⁾
	125	18	47,5	51	2,08	16,3	13 000	19 000	0,47	71918 CD/HCP4A ³⁾	SEB 90 /NS 7CE1 ³⁾
	125	18	44,2	48	1,96	–	8 500	14 000	0,55	71918 ACD/P4A ³⁾	SEB 90 7CE3 ³⁾
	125	18	44,2	48	1,96	–	10 000	17 000	0,47	71918 ACD/HCP4A ³⁾	SEB 90 /NS 7CE3 ³⁾
	140	24	79,3	76,5	3	15,6	9 000	15 000	1,15	7018 CD/P4A ³⁾	EX 90 7CE1 ³⁾
	140	24	79,3	76,5	3	15,6	11 000	18 000	0,95	7018 CD/HCP4A ³⁾	EX 90 /NS 7CE1 ³⁾
	140	24	74,1	72	2,85	–	8 500	13 000	1,15	7018 ACD/P4A ³⁾	EX 90 7CE3 ³⁾
	140	24	74,1	72	2,85	–	10 000	16 000	0,95	7018 ACD/HCP4A ³⁾	EX 90 /NS 7CE3 ³⁾
95	130	18	49,4	55	2,2	16,4	9 000	15 000	0,58	71919 CD/P4A	SEB 95 7CE1
	130	18	49,4	55	2,2	16,4	12 000	18 000	0,49	71919 CD/HCP4A	SEB 95 /NS 7CE1
	130	18	46,2	52	2,08	–	8 500	14 000	0,58	71919 ACD/P4A	SEB 95 7CE3
	130	18	46,2	52	2,08	–	9 500	16 000	0,49	71919 ACD/HCP4A	SEB 95 /NS 7CE3
	145	24	81,9	80	3,1	15,7	8 500	14 000	1,20	7019 CD/P4A	EX 95 7CE1
	145	24	81,9	80	3,1	15,7	11 000	17 000	1,00	7019 CD/HCP4A	EX 95 /NS 7CE1
	145	24	76,1	76,5	2,9	–	8 000	13 000	1,20	7019 ACD/P4A	EX 95 7CE3
	145	24	76,1	76,5	2,9	–	10 000	16 000	1,00	7019 ACD/HCP4A	EX 95 /NS 7CE3
100	140	20	60,5	65,5	2,55	16,3	8 500	14 000	0,80	71920 CD/P4A	SEB 100 7CE1
	140	20	60,5	65,5	2,55	16,3	11 000	17 000	0,66	71920 CD/HCP4A	SEB 100 /NS 7CE1
	140	20	57,2	63	2,4	–	8 000	13 000	0,80	71920 ACD/P4A	SEB 100 7CE3
	140	20	57,2	63	2,4	–	9 000	15 000	0,66	71920 ACD/HCP4A	SEB 100 /NS 7CE3
	150	24	83,2	85	3,2	15,8	8 500	14 000	1,25	7020 CD/P4A ³⁾	EX 100 7CE1 ³⁾
	150	24	83,2	85	3,2	15,8	10 000	16 000	1,05	7020 CD/HCP4A ³⁾	EX 100 /NS 7CE1 ³⁾
	150	24	79,3	80	3,05	–	8 000	12 000	1,25	7020 ACD/P4A ³⁾	EX 100 7CE3 ³⁾
	150	24	79,3	80	3,05	–	9 500	15 000	1,05	7020 ACD/HCP4A ³⁾	EX 100 /NS 7CE3 ³⁾
105	145	20	61,8	69,5	2,6	16,4	8 500	14 000	0,82	71921 CD/P4A	SEB 105 7CE1
	145	20	61,8	69,5	2,6	16,4	10 000	16 000	0,69	71921 CD/HCP4A	SEB 105 /NS 7CE1
	145	20	57,2	65,5	2,5	–	7 500	12 000	0,82	71921 ACD/P4A	SEB 105 7CE3
	145	20	57,2	65,5	2,5	–	9 000	15 000	0,69	71921 ACD/HCP4A	SEB 105 /NS 7CE3
	160	26	95,6	96,5	3,6	15,7	8 000	13 000	1,60	7021 CD/P4A	EX 105 7CE1
	160	26	95,6	96,5	3,6	15,7	10 000	15 000	1,35	7021 CD/HCP4A	EX 105 /NS 7CE1
	160	26	90,4	93	3,4	–	7 500	12 000	1,60	7021 ACD/P4A	EX 105 7CE3
	160	26	90,4	93	3,4	–	9 000	14 000	1,35	7021 ACD/HCP4A	EX 105 /NS 7CE3
110	150	20	62,4	72	2,7	16,5	8 000	13 000	0,86	71922 CD/P4A ³⁾	SEB 110 7CE1 ³⁾
	150	20	62,4	72	2,7	16,5	10 000	16 000	0,72	71922 CD/HCP4A ³⁾	SEB 110 /NS 7CE1 ³⁾
	150	20	58,5	68	2,55	–	7 500	12 000	0,86	71922 ACD/P4A ³⁾	SEB 110 7CE3 ³⁾
	150	20	58,5	68	2,55	–	8 500	14 000	0,72	71922 ACD/HCP4A ³⁾	SEB 110 /NS 7CE3 ³⁾
	170	28	111	108	3,9	15,5	7 500	12 000	1,95	7022 CD/P4A	EX 110 7CE1
	170	28	111	108	3,9	15,5	9 500	14 000	1,60	7022 CD/HCP4A	EX 110 /NS 7CE1
	170	28	104	104	3,75	–	7 000	11 000	1,95	7022 ACD/P4A	EX 110 7CE3
	170	28	104	104	3,75	–	8 500	13 000	1,60	7022 ACD/HCP4A	EX 110 /NS 7CE3

¹⁾ Applicable to open bearings only

²⁾ For designations of sealed bearings and other variants, refer to table 16 on pages 34 and 35.

³⁾ Bearing is available with a PEEK cage, designation suffix TNHA (KE), on request.

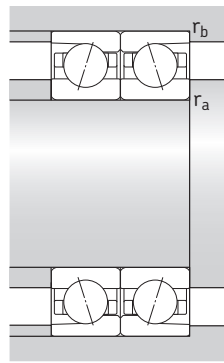
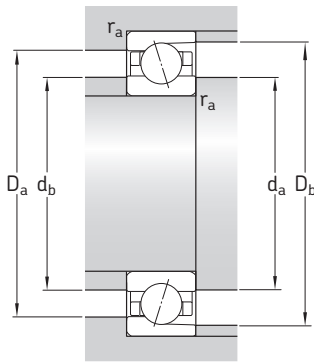

Dimensions

Abutment and fillet dimensions

d	d ₁ ~	D ₁ ~	r _{1,2} min	r _{3,4} min	a	d _{a,d_b} min	D _a max	D _b max	r _a max	r _b max
mm						mm				
90	100,8	114,2	1,1	0,6	23	96	119	121	1	0,6
	100,8	114,2	1,1	0,6	23	96	119	121	1	0,6
	100,8	114,2	1,1	0,6	34	96	119	121	1	0,6
	100,8	114,2	1,1	0,6	34	96	119	121	1	0,6
	105,4	124,6	1,5	1	28	97	133	136	1,5	1
	105,4	124,6	1,5	1	28	97	133	136	1,5	1
	105,4	124,6	1,5	1	39	97	133	136	1,5	1
	105,4	124,6	1,5	1	39	97	133	136	1,5	1
95	105,8	119,2	1,1	0,6	24	101	124	126	1	0,6
	105,8	119,2	1,1	0,6	24	101	124	126	1	0,6
	105,8	119,2	1,1	0,6	35	101	124	126	1	0,6
	105,8	119,2	1,1	0,6	35	101	124	126	1	0,6
	110,4	129,6	1,5	1	28	102	138	141	1,5	1
	110,4	129,6	1,5	1	28	102	138	141	1,5	1
	110,4	129,6	1,5	1	40	102	138	141	1,5	1
	110,4	129,6	1,5	1	40	102	138	141	1,5	1
100	112,3	127,7	1,1	0,6	26	106	134	136	1	0,6
	112,3	127,7	1,1	0,6	26	106	134	136	1	0,6
	112,3	127,7	1,1	0,6	38	106	134	136	1	0,6
	112,3	127,7	1,1	0,6	38	106	134	136	1	0,6
	115,4	134,6	1,5	1	29	107	143	146	1,5	1
	115,4	134,6	1,5	1	29	107	143	146	1,5	1
	115,4	134,6	1,5	1	41	107	143	146	1,5	1
	115,4	134,6	1,5	1	41	107	143	146	1,5	1
105	117,3	132,7	1,1	0,6	27	111	139	141	1	0,6
	117,3	132,7	1,1	0,6	27	111	139	141	1	0,6
	117,3	132,7	1,1	0,6	39	111	139	141	1	0,6
	117,3	132,7	1,1	0,6	39	111	139	141	1	0,6
	121,9	143,1	2	1	31	114	151	155	2	1
	121,9	143,1	2	1	31	114	151	155	2	1
	121,9	143,1	2	1	44	114	151	155	2	1
	121,9	143,1	2	1	44	114	151	155	2	1
110	122,3	137,7	1,1	0,6	27	116	144	146	1	0,6
	122,3	137,7	1,1	0,6	27	116	144	146	1	0,6
	122,3	137,7	1,1	0,6	40	116	144	146	1	0,6
	122,3	137,7	1,1	0,6	40	116	144	146	1	0,6
	128,5	151,5	2	1	33	119	161	165	2	1
	128,5	151,5	2	1	33	119	161	165	2	1
	128,5	151,5	2	1	47	119	161	165	2	1
	128,5	151,5	2	1	47	119	161	165	2	1

Super-precision angular contact ball bearings

d 120 – 170 mm

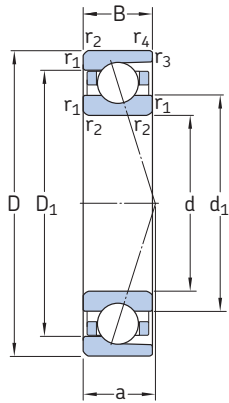

Open variant

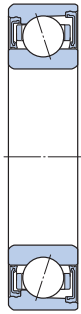

Sealed variant
for d = 10 to 150 mm

Principal dimensions			Basic load ratings		Fatigue load limit	Calculation factor	Attainable speeds		Mass ¹⁾	Designations of open bearings ²⁾	
d	D	B	C	C ₀	P _u	f ₀	when lubricating with grease	oil-air ¹⁾	kg	SKF	SNFA
mm			kN		kN	–	r/min		kg	–	
120	165	22	78	91,5	3,25	16,5	7 500	12 000	1,15	71924 CD/P4A	SEB 120 7CE1
	165	22	78	91,5	3,25	16,5	9 000	14 000	0,97	71924 CD/HCP4A	SEB 120 /NS 7CE1
	165	22	72,8	86,5	3,05	–	7 000	11 000	1,15	71924 ACD/P4A	SEB 120 7CE3
	165	22	72,8	86,5	3,05	–	8 000	13 000	0,97	71924 ACD/HCP4A	SEB 120 /NS 7CE3
	180	28	114	122	4,25	15,7	7 000	11 000	2,10	7024 CD/P4A	EX 120 7CE1
	180	28	114	122	4,25	15,7	8 500	13 000	1,75	7024 CD/HCP4A	EX 120 /NS 7CE1
	180	28	111	116	4	–	6 700	10 000	2,10	7024 ACD/P4A	EX 120 7CE3
	180	28	111	116	4	–	8 000	12 000	1,75	7024 ACD/HCP4A	EX 120 /NS 7CE3
130	180	24	92,3	108	3,65	16,4	7 000	11 000	1,55	71926 CD/P4A ³⁾	SEB 130 7CE1 ³⁾
	180	24	92,3	108	3,65	16,4	8 500	13 000	1,30	71926 CD/HCP4A ³⁾	SEB 130 /NS 7CE1 ³⁾
	180	24	87,1	102	3,45	–	6 700	10 000	1,55	71926 ACD/P4A ³⁾	SEB 130 7CE3 ³⁾
	180	24	87,1	102	3,45	–	7 500	12 000	1,30	71926 ACD/HCP4A ³⁾	SEB 130 /NS 7CE3 ³⁾
	200	33	148	156	5,2	15,6	7 000	10 000	3,20	7026 CD/P4A	EX 130 7CE1
	200	33	140	150	4,9	–	6 000	9 000	3,20	7026 ACD/P4A	EX 130 7CE3
140	190	24	95,6	116	3,9	16,6	6 700	10 000	1,65	71928 CD/P4A	SEB 140 7CE1
	190	24	95,6	116	3,9	16,6	8 000	12 000	1,35	71928 CD/HCP4A	SEB 140 /NS 7CE1
	190	24	90,4	110	3,65	–	6 000	9 000	1,65	71928 ACD/P4A	SEB 140 7CE3
	190	24	90,4	110	3,65	–	7 000	11 000	1,35	71928 ACD/HCP4A	SEB 140 /NS 7CE3
	210	33	153	166	5,3	15,8	6 700	10 000	3,40	7028 CD/P4A	EX 140 7CE1
	210	33	146	156	5,1	–	5 600	8 500	3,40	7028 ACD/P4A	EX 140 7CE3
	150	210	28	125	146	4,75	16,2	6 300	9 500	2,55	71930 CD/P4A ³⁾
210	28	125	146	4,75	16,2	7 500	11 000	2,10	71930 CD/HCP4A ³⁾	SEB 150 /NS 7CE1 ³⁾	
210	28	119	140	4,5	–	5 600	8 500	2,55	71930 ACD/P4A ³⁾	SEB 150 7CE3 ³⁾	
210	28	119	140	4,5	–	6 700	10 000	2,10	71930 ACD/HCP4A ³⁾	SEB 150 /NS 7CE3 ³⁾	
225	35	172	190	5,85	15,8	6 000	9 000	4,15	7030 CD/P4A	EX 150 7CE1	
225	35	163	180	5,6	–	5 300	8 000	4,15	7030 ACD/P4A	EX 150 7CE3	
160	220	28	130	160	5	16,4	6 000	9 000	2,70	71932 CD/P4A	SEB 160 7CE1
	220	28	130	160	5	16,4	7 500	11 000	2,25	71932 CD/HCP4A	SEB 160 /NS 7CE1
	220	28	124	153	4,75	–	5 300	8 000	2,70	71932 ACD/P4A	SEB 160 7CE3
	220	28	124	153	4,75	–	6 300	9 500	2,25	71932 ACD/HCP4A	SEB 160 /NS 7CE3
	240	38	195	216	6,55	15,8	5 600	8 500	5,10	7032 CD/P4A	EX 160 7CE1
	240	38	182	204	6,2	–	5 000	7 500	5,10	7032 ACD/P4A	EX 160 7CE3
	170	230	28	133	166	5,1	16,5	5 600	8 500	2,85	71934 CD/P4A
230	28	133	166	5,1	16,5	7 000	10 000	2,35	71934 CD/HCP4A	SEB 170 /NS 7CE1	
230	28	124	160	4,8	–	5 000	7 500	2,85	71934 ACD/P4A	SEB 170 7CE3	
230	28	124	160	4,8	–	6 000	9 000	2,35	71934 ACD/HCP4A	SEB 170 /NS 7CE3	
260	42	212	245	7,1	15,9	5 300	8 000	6,85	7034 CD/P4A	EX 170 7CE1	
260	42	199	232	6,7	–	4 800	7 000	6,85	7034 ACD/P4A	EX 170 7CE3	

¹⁾ Applicable to open bearings only

²⁾ For designations of sealed bearings and other variants, refer to table 16 on pages 34 and 35.

³⁾ Bearing is available with a PEEK cage, designation suffix TNHA (KE), on request.

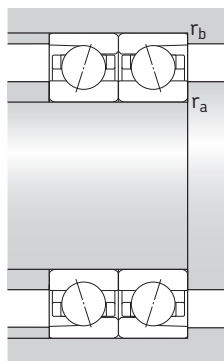
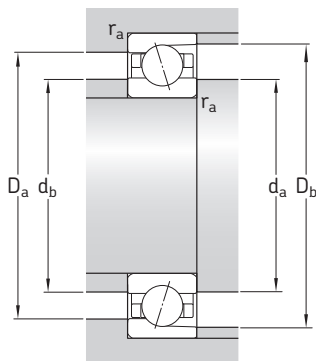

Dimensions

Abutment and fillet dimensions

d	d ₁ ~	D ₁ ~	r _{1,2} min	r _{3,4} min	a	d _{a,d_b} min	D _a max	D _b max	r _a max	r _b max
mm						mm				
120	133,9	151,1	1,1	0,6	30	126	159	161	1	0,6
	133,9	151,1	1,1	0,6	30	126	159	161	1	0,6
	133,9	151,1	1,1	0,6	44	126	159	161	1	0,6
	133,9	151,1	1,1	0,6	44	126	159	161	1	0,6
	138,5	161,5	2	1	34	129	171	175	2	1
	138,5	161,5	2	1	34	129	171	175	2	1
	138,5	161,5	2	1	49	129	171	175	2	1
	138,5	161,5	2	1	49	129	171	175	2	1
130	145,4	164,6	1,5	0,6	33	137	173	176	1,5	0,6
	145,4	164,6	1,5	0,6	33	137	173	176	1,5	0,6
	145,4	164,6	1,5	0,6	48	137	173	176	1,5	0,6
	145,4	164,6	1,5	0,6	48	137	173	176	1,5	0,6
	151,6	178,4	2	1	39	139	191	195	2	1
	151,6	178,4	2	1	55	139	191	195	2	1
140	155,4	174,6	1,5	0,6	34	147	183	186	1,5	0,6
	155,4	174,6	1,5	0,6	34	147	183	186	1,5	0,6
	155,4	174,6	1,5	0,6	51	147	183	186	1,5	0,6
	155,4	174,6	1,5	0,6	51	147	183	186	1,5	0,6
	161,6	188,4	2	1	40	149	201	205	2	1
	161,6	188,4	2	1	58	149	201	205	2	1
	161,6	188,4	2	1	58	149	201	205	2	1
150	168,5	191,5	2	1	38	159	201	205	2	1
	168,5	191,5	2	1	38	159	201	205	2	1
	168,5	191,5	2	1	56	159	201	205	2	1
	168,5	191,5	2	1	56	159	201	205	2	1
	173,1	201,9	2,1	1	43	161	214	220	2	1
	173,1	201,9	2,1	1	62	161	214	220	2	1
	173,1	201,9	2,1	1	62	161	214	220	2	1
160	178,5	201,5	2	1	40	169	211	215	2	1
	178,5	201,5	2	1	40	169	211	215	2	1
	178,5	201,5	2	1	58	169	211	215	2	1
	178,5	201,5	2	1	58	169	211	215	2	1
	184,7	215,3	2,1	1	46	171	229	235	2	1
	184,7	215,3	2,1	1	66	171	229	235	2	1
	184,7	215,3	2,1	1	66	171	229	235	2	1
170	188,5	211,5	2	1	41	179	221	225	2	1
	188,5	211,5	2	1	41	179	221	225	2	1
	188,5	211,5	2	1	61	179	221	225	2	1
	188,5	211,5	2	1	61	179	221	225	2	1
	198,7	231,3	2,1	1,1	50	181	249	254	2	1
	198,7	231,3	2,1	1,1	71	181	249	254	2	1
	198,7	231,3	2,1	1,1	71	181	249	254	2	1

Super-precision angular contact ball bearings

d 180 – 360 mm

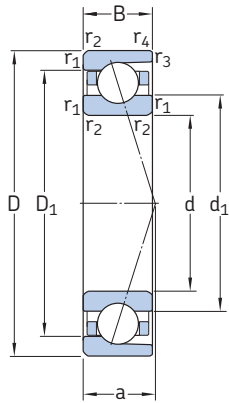

Open variant

Principal dimensions			Basic load ratings		Fatigue load limit	Calculation factor	Attainable speeds		Mass	Designations of open bearings ¹⁾	SNFA
d	D	B	C	C ₀			P _u	f ₀			
mm			kN		kN	–	r/min		kg	–	
180	250	33	168	212	6,1	16,3	5 300	8 000	4,20	71936 CD/P4A	SEB 180 7CE1
	250	33	159	200	5,85	–	4 800	7 000	4,20	71936 ACD/P4A	SEB 180 7CE3
	280	46	242	290	8,15	15,7	5 000	7 500	8,90	7036 CD/P4A	EX 180 7CE1
	280	46	229	275	7,65	–	4 300	6 300	8,90	7036 ACD/P4A	EX 180 7CE3
190	260	33	172	220	6,2	16,4	5 000	7 500	4,35	71938 CD/P4A	SEB 190 7CE1
	260	33	163	208	5,85	–	4 500	6 700	4,35	71938 ACD/P4A	SEB 190 7CE3
	290	46	247	305	8,3	15,9	4 800	7 000	9,35	7038 CD/P4A	EX 190 7CE1
	290	46	234	290	8	–	4 300	6 300	9,35	7038 ACD/P4A	EX 190 7CE3
200	280	38	208	265	7,2	16,3	4 800	7 000	6,10	71940 CD/P4A	SEB 200 7CE1
	280	38	199	250	6,8	–	4 300	6 300	6,10	71940 ACD/P4A	SEB 200 7CE3
	310	51	296	390	10,2	15,6	4 500	6 700	12,0	7040 CD/P4A	EX 200 7CE1
	310	51	281	365	9,8	–	4 000	6 000	12,0	7040 ACD/P4A	EX 200 7CE3
220	300	38	221	300	7,8	16,5	4 300	6 300	6,60	71944 CD/P4A	SEB 220 7CE1
	300	38	208	285	7,5	–	3 800	5 600	6,60	71944 ACD/P4A	SEB 220 7CE3
	340	56	338	455	11,6	15,6	4 000	6 000	16,0	7044 CD/P4A	EX 220 7CE1
	340	56	319	440	11	–	3 600	5 300	16,0	7044 ACD/P4A	EX 220 7CE3
240	320	38	229	325	8,15	16,7	3 800	5 600	7,20	71948 CD/P4A	SEB 240 7CE1
	320	38	216	305	7,8	–	3 200	4 800	7,20	71948 ACD/P4A	SEB 240 7CE3
	360	56	345	490	12	15,8	3 800	5 600	17,0	7048 CD/P4A	EX 240 7CE1
	360	56	325	465	11,4	–	3 400	5 000	17,0	7048 ACD/P4A	EX 240 7CE3
260	360	46	281	425	10,2	16,5	3 400	5 000	12,0	71952 CD/P4A	SEB 260 7CE1
	360	46	265	400	9,65	–	2 800	4 300	12,0	71952 ACD/P4A	SEB 260 7CE3
280	380	46	291	455	10,6	16,7	3 200	4 800	13,0	71956 CD/P4A	SEB 280 7CE1
	380	46	276	430	10	–	2 600	4 000	13,0	71956 ACD/P4A	SEB 280 7CE3
300	420	56	371	600	13,4	16,3	2 400	3 600	23,0	71960 CDMA/P4A	SEB 300 7LE1
	420	56	351	560	12,7	–	2 200	3 400	23,0	71960 ACDMA/P4A	SEB 300 7LE3
320	440	56	377	620	13,7	16,5	2 200	3 400	24,0	71964 CDMA/P4A	SEB 320 7LE1
	440	56	351	585	12,9	–	2 000	3 200	24,0	71964 ACDMA/P4A	SEB 320 7LE3
340	460	56	390	670	14,3	17	2 000	3 200	25,5	71968 CDMA/P4A	SEB 340 7LE1
	460	56	364	640	13,4	–	1 900	3 000	25,5	71968 ACDMA/P4A	SEB 340 7LE3
360	480	56	397	710	14,6	16,5	1 900	3 000	26,7	71972 CDMA/P4A	SEB 360 7LE1
	480	56	371	670	13,7	–	1 800	2 800	26,7	71972 ACDMA/P4A	SEB 360 7LE3

¹⁾ For designations of other variants, refer to table 16 on pages 34 and 35.

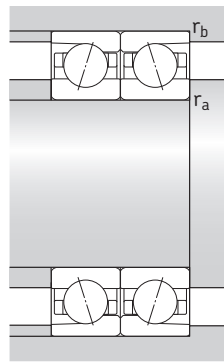
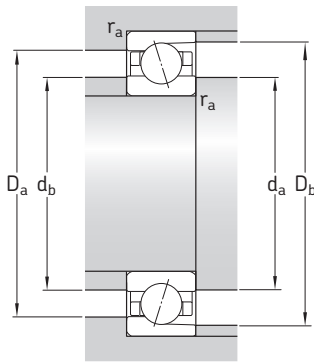

Dimensions

Abutment and fillet dimensions

d	d ₁ ~	D ₁ ~	r _{1,2} min	r _{3,4} min	a	d _{a,d_b} min	D _a max	D _b max	r _a max	r _b max
mm						mm				
180	201,6	228,4	2	1	45	189	241	245	2	1
	201,6	228,4	2	1	67	189	241	245	2	1
	211,8	248,2	2,1	1,1	54	191	269	274	2	1
	211,8	248,2	2,1	1,1	77	191	269	274	2	1
190	211,6	238,4	2	1	47	199	251	255	2	1
	211,6	238,4	2	1	69	199	251	255	2	1
	221,8	258,2	2,1	1,1	55	201	279	284	2	1
	221,8	258,2	2,1	1,1	79	201	279	284	2	1
200	224,7	255,3	2,1	1	51	209	271	275	2	1
	224,7	255,3	2,1	1	75	209	271	275	2	1
	233,9	276,1	2,1	1,1	60	211	299	304	2	1
	233,9	276,1	2,1	1,1	85	211	299	304	2	1
220	244,7	275,3	2,1	1	54	231	289	295	2	1
	244,7	275,3	2,1	1	80	231	289	295	2	1
	257	303	3	1,5	66	233	327	334	2,5	1,5
	257	303	3	1,5	94	233	327	334	2,5	1,5
240	264,7	295,3	2,1	1	57	251	309	315	2	1
	264,7	295,3	2,1	1	84	251	309	315	2	1
	277	323	3	1,5	68	253	347	354	2,5	1,5
	277	323	3	1,5	98	253	347	354	2,5	1,5
260	291,8	328,2	2,1	1,1	65	271	349	354	2	1
	291,8	328,2	2,1	1,1	96	271	349	354	2	1
280	311,8	348,2	2,1	1,1	67	291	369	374	2	1
	311,8	348,2	2,1	1,1	100	291	369	374	2	1
300	337	383	3	1,1	76	313	407	414	2,5	1
	337	383	3	1,1	112	313	407	414	2,5	1
320	357,2	403	3	1,1	79	333	427	434	2,5	1
	357,2	403	3	1,1	117	333	427	434	2,5	1
340	377,2	423	3	1,1	82	353	447	454	2,5	1
	377,2	423	3	1,1	122	353	447	454	2,5	1
360	397	443	3	1,1	84	373	467	474	2,5	1
	397	443	3	1,1	126	373	467	474	2,5	1

SKF new generation super-precision bearings

SKF has developed and is continuing to develop a new, improved generation of super-precision bearings. The new assortment delivers improved accuracy and extended bearing service life when compared to previous designs

Table 1 on pages 52 and 53 provides an overview of the new assortment of SKF super-precision bearings.

Super-precision angular contact ball bearings

Bearings in the 718 (SEA) series

Bearings in the 718 (SEA) series provide optimum performance in applications where a low cross section and high degree of rigidity, speed and superior accuracy are critical design parameters. They are particularly suitable for machine tool applications, multi-spindle drilling heads, robotic arms, measuring devices, racing car wheels and other precision applications. The standard assortment accommodates shaft diameters ranging from 10 to 160 mm.



Bearings in the S719 .. B (HB .. /S) and S70 .. B (HX .. /S) series

High-speed sealed bearings in the S719 .. B (HB .. /S) and S70 .. B (HX .. /S) series can virtually eliminate the problem of premature bearing failures resulting from contamination. The standard assortment accommodates shaft diameters ranging from 30 to 120 mm. These relubrication-free bearings are particularly suitable for metal cutting and woodworking machines. The bearings are also available in an open variant.



Bearings in the 72 .. D (E 200) series

High-capacity bearings in the 72 .. D (E 200) series offer solutions to many bearing arrangement challenges. Their ability, among others, to provide a high degree of rigidity and accommodate heavy loads at relatively high speeds, is beneficial for a variety of applications. The extended range of bearings in this series now accommodates shaft diameters ranging from 7 to 140 mm. And, there is also a relubrication-free, sealed variant, available on request.



Bearings in the 719 .. E (VEB) and 70 .. E (VEX) series

Compared to high-speed B design bearings, high-speed E design bearings have a higher speed capability and can accommodate heavier loads. This desirable combination makes these bearings an excellent choice for demanding applications.

Open bearings in the 719 .. E (VEB) series accommodate shaft diameters ranging from 8 to 120 mm; sealed bearings from 20 to 120 mm.

Open bearings in the 70 .. E (VEX) series accommodate shaft diameters ranging from 6 to 120 mm; sealed bearings from 10 to 120 mm.



Bearings made from NitroMax steel

In extremely demanding applications such as high-speed machining centres and milling machines, bearings are frequently subjected to difficult operating conditions such as very high speeds, thin-film lubrication conditions, and contaminated and corrosive environments. To enable longer bearing service life and reduce the costs associated with downtime, SKF has developed a superior high-nitrogen steel.

The SKF assortment of super-precision angular contact ball bearings made from NitroMax steel have ceramic (bearing grade silicon nitride) rolling elements as standard.

Super-precision cylindrical roller bearings

SKF produces super-precision single row and double row cylindrical roller bearings. The characteristic features of these bearings are a low cross sectional height, high load carrying capacity, high rigidity and high-speed capability. They are therefore particularly well suited for machine tool spindles where the bearing arrangement must accommodate heavy radial loads and high speeds, while providing a high degree of stiffness.

Single row cylindrical roller bearings are produced in the N 10 series as basic design bearings and as high-speed design bearings. High-speed single row cylindrical roller bearings in the N 10 series are available with a tapered bore only and for shaft diameters ranging from 40 to 80 mm. Compared to previous high-speed design, they can accommodate a speed increase of up to 30% in grease lubricated applications and up to 15% in oil-air lubricated applications.

Double row cylindrical roller bearings are produced as standard in the NN design and NNU design.

Super-precision double direction angular contact thrust ball bearings

Double direction angular contact bearings, as their name implies, were developed by SKF to axially locate machine tool spindles in both directions.

The new optimized design of super-precision bearings in the BTW series consists of a set of two single row angular contact thrust ball bearings, arranged back-to-back. This configuration enables the bearings to accommodate axial loads in both directions while providing a high degree of system rigidity. These bearings can accommodate higher speeds compared to bearings in the former 2344(00) series. The bearings are available for shaft diameters ranging from 35 to 200 mm.

The redesigned high-speed BTM series accommodate higher speeds, anywhere from 6% to 12% depending on the size; minimize heat generation, even at higher speeds; provide high load carrying capacity and maintain a high degree of system rigidity. The range of BTM bearings series has been expanded to accommodate shaft diameters from 60 to 180 mm.

Super-precision angular contact thrust ball bearings for screw drives

Single direction angular contact thrust ball bearings in the BSA and BSD (*BS*) series are available for shaft diameters ranging from 12 to 75 mm. These bearings are characterized by superior axial stiffness and high axial load carrying capacity.

Double direction angular contact thrust ball bearings in the BEAS series have been developed for machine tool applications where space is tight and easy mounting is required. The bearings are available for shaft diameters ranging from 8 to 30 mm. Bearings in the BEAM series, which can accommodate shaft diameters ranging from 12 to 60 mm, can be bolt-mounted to an associated component.

Cartridge units are another solution for simple and quick mounting. Units in the FBSA (*BSDU and BSQU*) series incorporate SKF single direction angular contact thrust ball bearings and can accommodate shaft diameters ranging from 20 to 60 mm.

Super-precision axial-radial cylindrical roller bearings

SKF axial-radial cylindrical roller bearings are suitable for arrangements that have simultaneously acting (radial and axial) loads as well as moment loads.





Their internal design, together with close tolerance manufacturing processes, enable these bearings to attain better than P4 running accuracy.

Axial-radial cylindrical roller bearings are commonly used to support rotating tables, indexing tables and milling heads.



Table 1







Overview of SKF super-precision bearings

ISO dimension series	Bearing type and design <i>SKF publication^{1,2)}</i>		Variant	SKF assortment SKF bearings in the series		
18	Angular contact ball bearings: Basic design <i>Super-precision angular contact ball bearings: 718 (SEA) series (Publication No. 06810)</i>		Open	All-steel Hybrid	718 .. D (SEA) 718 .. D/HC (SEA/NS)	
			Angular contact ball bearings: High-speed, B design <i>Super-precision angular contact ball bearings: High-speed, B design, sealed as standard (Publication No. 06939)</i>	Open	All-steel Hybrid	719 .. B (HB) 719 .. B/HC (HB/NS)
				Sealed	All-steel Hybrid	S719 .. B (HB/S) S719 .. B/HC (HB/S/NS)
				Angular contact ball bearings: High-speed, E design <i>Super-precision angular contact ball bearings: High-speed, E design (Publication No. 10112)</i>	Open	All-steel Hybrid
Sealed	All-steel Hybrid	S719 .. E (VEB/S) S719 .. E/HC (VEB/S/NS)				
19	Angular contact ball bearings: High-capacity, basic design <i>Super-precision angular contact ball bearings: High-capacity 719 .. D (SEB) and 70 .. D (EX) series (Publication No. 10527)</i>		Open	All-steel Hybrid	719 .. D (SEB) 719 .. D/HC (SEB/NS)	
			Sealed	All-steel Hybrid	S719 .. D (SEB/S) S719 .. D/HC (SEB/S/NS)	
			Angular contact ball bearings: High-speed, B design <i>Super-precision angular contact ball bearings: High-speed, B design, sealed as standard (Publication No. 06939)</i>	Open	All-steel Hybrid	70 .. B (HX) 70 .. B/HC (HX/NS)
				Sealed	All-steel Hybrid	S70 .. B (HX/S) S70 .. B/HC (HX/S/NS)
10	Angular contact ball bearings: High-speed, E design <i>Super-precision angular contact ball bearings: High-speed, E design (Publication No. 10112)</i>		Open	All-steel Hybrid	70 .. E (VEX) 70 .. E/HC (VEX/NS)	
			Sealed	All-steel Hybrid	S70 .. E (VEX/S) S70 .. E/HC (VEX/S/NS)	
			Angular contact ball bearings: High-capacity, basic design <i>Super-precision angular contact ball bearings: High-capacity 719 .. D (SEB) and 70 .. D (EX) series (Publication No. 10527)</i>	Open	All-steel Hybrid	70 .. D (EX) 70 .. D/HC (EX/NS)
Sealed	All-steel Hybrid	S70 .. D (EX/S) S70 .. D/HC (EX/S/NS)				
02	Angular contact ball bearings: High-capacity, basic design <i>Super-precision angular contact ball bearings: High-capacity (Publication No. 06981)</i>		Open	All-steel Hybrid	72 .. D (E 200) 72 .. D/HC (E 200/NS)	
			Sealed	All-steel Hybrid	S72 .. D (E 200/S) S72 .. D/HC (E 200/S/NS)	
49	Double row cylindrical roller bearings: NNU design		Open	All-steel	NNU 49 BK	

¹⁾ Where applicable, information can be found in the SKF publication *High-precision bearings* (Publication No. 6002).

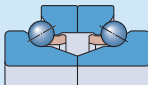
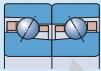
²⁾ For additional information about super-precision angular contact ball bearings made from NitroMax steel, refer to the SKF publication *Extend bearing service life with NitroMax* (Publication No. 10126).

Overview of SKF super-precision bearings

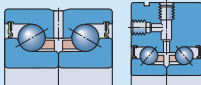
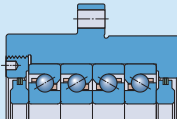
ISO dimension series	Bearing type and design <i>SKF publication^{1,2)}</i>		Variant		SKF assortment SKF bearings in the series
10	Single row cylindrical roller bearings: Basic design		Open	All-steel Hybrid	N 10 KTN N 10 KTN/HC5
	Single row cylindrical roller bearings: High-speed design <i>Super-precision cylindrical roller bearings: High-speed (Publication No. 07016)</i>		Open	All-steel Hybrid	N 10 KPHA N 10 KPHA/HC5
30	Double row cylindrical roller bearings: NN design		Open	All-steel Hybrid	NN 30 KTN NN 30 KTN/HC5
– (Non-standardized)	Angular contact thrust ball bearings: Double direction, basic design <i>Super-precision double direction angular contact thrust ball bearings (Publication No. 10097)</i>		Open	All-steel Hybrid	BTW BTW /HC
	Angular contact thrust ball bearings: Double direction, high-speed design <i>Higher-speed capability with the new BTM bearing series design (Publication No. 12119)</i>		Open	All-steel Hybrid	BTM BTM /HC
02	Angular contact thrust ball bearings: Single direction <i>Super-precision angular contact thrust ball bearings for screw drives (Publication No. 06570)</i>		Open Sealed	All-steel All-steel	BSA 2 (BS 200) BSA 2 .. (BS 200 ..)
03	Angular contact thrust ball bearings: Single direction <i>Super-precision angular contact thrust ball bearings for screw drives (Publication No. 06570)</i>		Open Sealed	All-steel All-steel	BSA 3 (BS 3) BSA 3 .. (BS 3 ..)
– (Non-standardized)	Angular contact thrust ball bearings: Single direction <i>Super-precision angular contact thrust ball bearings for screw drives (Publication No. 06570)</i>		Open Sealed	All-steel All-steel	BSD (BS ..) BSD .. (BS ..)
	Angular contact thrust ball bearings: Double direction		Sealed	All-steel	BEAS (BEAS) BEAM (BEAM)
	Cartridge unit with angular contact thrust ball bearings		Sealed	All-steel	FBSA (BSDU, BSQU) –

¹⁾ Where applicable, information can be found in the SKF publication *High-precision bearings* (Publication No. 6002).

²⁾ For additional information about super-precision angular contact ball bearings made from NitroMax steel, refer to the SKF publication *Extend bearing service life with NitroMax* (Publication No. 10126).

SKF – the knowledge engineering company

From the company that invented the self-aligning ball bearing more than 100 years ago, SKF has evolved into a knowledge engineering company that is able to draw on five technology platforms to create unique solutions for its customers. These platforms include bearings, bearing units and seals, of course, but extend to other areas including: lubricants and lubrication systems, critical for long bearing life in many applications; mechatronics that combine mechanical and electronics knowledge into systems for more effective linear motion and sensorized solutions; and a full range of services, from design and logistics support to condition monitoring and reliability systems.

Though the scope has broadened, SKF continues to maintain the world's leadership in the design, manufacture and marketing of rolling bearings, as well as complementary products such as radial seals. SKF also holds an increasingly important position in the market for linear motion products, high-precision aerospace bearings, machine tool spindles and plant maintenance services.

The SKF Group is globally certified to ISO 14001, the international standard for environmental management, as well as OHSAS 18001, the health and safety management standard. Individual divisions have been approved for quality certification in accordance with ISO 9001 and other customer specific requirements.

With over 120 manufacturing sites worldwide and sales companies in 70 countries, SKF is a truly international corporation. In addition, our distributors and dealers in some 15 000 locations around the world, an e-business marketplace and a global distribution system put SKF close to customers for the supply of both products and services. In essence, SKF solutions are available wherever and whenever customers need them. Overall, the SKF brand and the corporation are stronger than ever. As the knowledge engineering company, we stand ready to serve you with world-class product competencies, intellectual resources, and the vision to help you succeed.



© Airbus – photo: e*im company, H. Goussé

Evolving by-wire technology

SKF has a unique expertise in the fast-growing by-wire technology, from fly-by-wire, to drive-by-wire, to work-by-wire. SKF pioneered practical fly-by-wire technology and is a close working partner with all aerospace industry leaders. As an example, virtually all aircraft of the Airbus design use SKF by-wire systems for cockpit flight control.

SKF is also a leader in automotive by-wire technology, and has partnered with automotive engineers to develop two concept cars, which employ SKF mechatronics for steering and braking. Further by-wire development has led SKF to produce an all-electric forklift truck, which uses mechatronics rather than hydraulics for all controls.

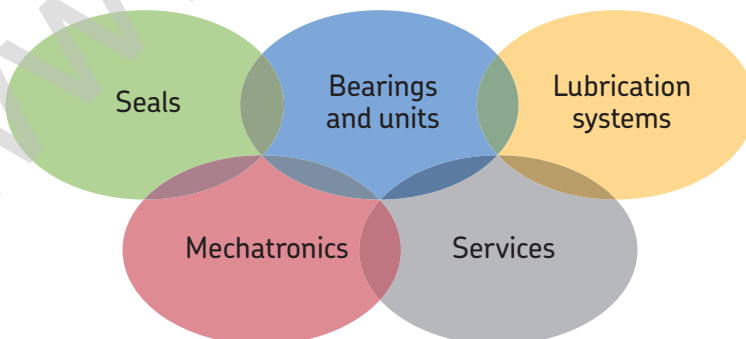



Harnessing wind power

The growing industry of wind-generated electric power provides a source of clean, green electricity. SKF is working closely with global industry leaders to develop efficient and trouble-free turbines, providing a wide range of large, highly specialized bearings and condition monitoring systems to extend equipment life of wind farms located in even the most remote and inhospitable environments.



Working in extreme environments

In frigid winters, especially in northern countries, extreme sub-zero temperatures can cause bearings in railway axleboxes to seize due to lubrication starvation. SKF created a new family of synthetic lubricants formulated to retain their lubrication viscosity even at these extreme temperatures. SKF knowledge enables manufacturers and end user customers to overcome the performance issues resulting from extreme temperatures, whether hot or cold. For example, SKF products are at work in diverse environments such as baking ovens and instant freezing in food processing plants.



Developing a cleaner cleaner

The electric motor and its bearings are the heart of many household appliances. SKF works closely with appliance manufacturers to improve their products' performance, cut costs, reduce weight, and reduce energy consumption. A recent example of this cooperation is a new generation of vacuum cleaners with substantially more suction. SKF knowledge in the area of small bearing technology is also applied to manufacturers of power tools and office equipment.



Maintaining a 350 km/h R&D lab

In addition to SKF's renowned research and development facilities in Europe and the United States, Formula One car racing provides a unique environment for SKF to push the limits of bearing technology. For over 60 years, SKF products, engineering and knowledge have helped make Scuderia Ferrari a formidable force in F1 racing. (The average racing Ferrari utilizes around 150 SKF components.) Lessons learned here are applied to the products we provide to automakers and the aftermarket worldwide.



Delivering Asset Efficiency Optimization

Through SKF Reliability Systems, SKF provides a comprehensive range of asset efficiency products and services, from condition monitoring hardware and software to maintenance strategies, engineering assistance and machine reliability programmes. To optimize efficiency and boost productivity, some industrial facilities opt for an Integrated Maintenance Solution, in which SKF delivers all services under one fixed-fee, performance-based contract.



Planning for sustainable growth

By their very nature, bearings make a positive contribution to the natural environment, enabling machinery to operate more efficiently, consume less power, and require less lubrication. By raising the performance bar for our own products, SKF is enabling a new generation of high-efficiency products and equipment. With an eye to the future and the world we will leave to our children, the SKF Group policy on environment, health and safety, as well as the manufacturing techniques, are planned and implemented to help protect and preserve the earth's limited natural resources. We remain committed to sustainable, environmentally responsible growth.

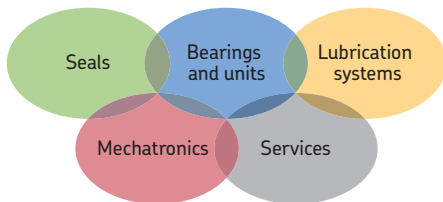

The Power of Knowledge Engineering

Drawing on five areas of competence and application-specific expertise amassed over more than 100 years, SKF brings innovative solutions to OEMs and production facilities in every major industry worldwide. These five competence areas include bearings and units, seals, lubrication systems, mechatronics (combining mechanics and electronics into intelligent systems), and a wide range of services, from 3-D computer modelling to advanced condition monitoring and reliability and asset management systems. A global presence provides SKF customers uniform quality standards and worldwide product availability.

www.lager-technik.eu

© SKF and SNFA are registered trademarks of the SKF Group.

™ NitroMax is a trademark of the SKF Group.

© SKF Group 2012

The contents of this publication are the copyright of the publisher and may not be reproduced (even extracts) unless prior written permission is granted. Every care has been taken to ensure the accuracy of the information contained in this publication but no liability can be accepted for any loss or damage whether direct, indirect or consequential arising out of the use of the information contained herein.

PUB BU/P9 10527/4 EN · February 2012

This publication supersedes all information about SKF bearings in the 719 .. D and 70 .. D series in the SKF publication *High-precision bearings* (Publication No. 6002) and SNFA bearings in the SEB and EX series in the *SNFA General Catalogue*.

Certain image(s) used under license from Shutterstock.com

